

FİYAT LİSTESİ

HAZİRAN 2018

Flex

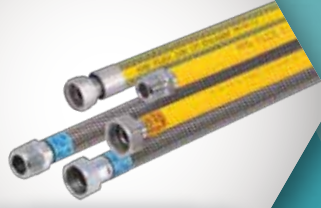

Kollektör



Armatür



**Su
Doğalgaz**



PPRC



KAS®

www.kas.com.tr





Armatür ve **Duř**
Setleri

05



Duř Setleri

46



Su ve **Doęalgaz**
Tesisat Ürünleri

59



Kollektör ve
Yerden **Isıtma** Grubu

75



Flex Grubu

81



PPRC Grubu

93



Aç kapada 2.000.000'u aştık
ÇİFT YILDIZI TAKTIK...



KAS Kalitesi
TSE Çift Yıldız Kalite Belgesi ile
Yıldızlandı...

Çift Yıldız Belgesi **KAS Kalitesinin** Standartlarda belirtilen şartların daha üzerinde olduğunun göstergesidir.

* Normal açma kapama standardı 210.000'dir.

KAS[®]

www.kas.com.tr

facebook.com/kasgrup
twitter.com/kasgrup_

KAS'DAN BİR İLK MODÜLER SÖKÜLEBİLİR SENSÖRLÜ BATARYA



KOLAY VE HIZLI DEĞİŞİM

- ▶ Su tasarrufu ▶ Kolay montaj ▶ Akıllı sensör
- ▶ Pili. Elektrik tesisatına gerek yok
- ▶ Uzun süreli su akıtma

www.kas.com.tr

facebook.com/kasgrup
twitter.com/kasgrup_

KAS[®]

Armatür ve Duş Setleri





ARMATÜR ÜRÜNLERİ

Yasemin Gold

Banyo Bataryası



KOD	K.AD.	B.FİYATI
92.41.901	10	917,00 TL

Lavabo Bataryası



KOD	K.AD.	B.FİYATI
92.41.902	6	801,00 TL

Eye Bataryası



KOD	K.AD.	B.FİYATI
92.41.904	6	1.205,00 TL



ARMATÜR ÜRÜNLERİ

Yasemin

Banyo Bataryası



KOD	K.AD.	B.FİYATI
92.41.801	10	863,00 TL

Lavabo Bataryası



KOD	K.AD.	B.FİYATI
92.41.802	6	634,00 TL

Eye Bataryası



KOD	K.AD.	B.FİYATI
92.41.804	6	932,00 TL



ARMATÜR ÜRÜNLERİ

Reyhan

Banyo Bataryası



KOD	K.AD.	B.FİYATI
92.31.301	12	265,50 TL

Lavabo Bataryası



KOD	K.AD.	B.FİYATI
92.31.302	12	178,90 TL

11

Kuğu Lavabo Bataryası



KOD	K.AD.	B.FİYATI
92.31.305	12	227,10 TL

Kuğu Eyje Bataryası



KOD	K.AD.	B.FİYATI
92.31.306	12	227,10 TL



ARMATÜR ÜRÜNLERİ

Reyhan

Aplike Bataryası



KOD	K.AD.	B.FİYATI
92.31.307	8	235,20 TL

Duş Bataryası



KOD	K.AD.	B.FİYATI
92.31.308	8	190,80 TL

Ay Kuğu Lavabo Bataryası



KOD	K.AD.	B.FİYATI
92.31.315	12	279,20 TL

Ay Kuğu Eveye Bataryası



KOD	K.AD.	B.FİYATI
92.31.316	12	279,50 TL



ARMATÜR ÜRÜNLERİ

Hilal

Banyo Bataryası



KOD	K.AD.	B.FİYATI
92.31.201	12	245,80 TL

Lavabo Bataryası



KOD	K.AD.	B.FİYATI
92.31.202	12	188,40 TL

15

Lüks Kuğu Lavabo Bataryası



KOD	K.AD.	B.FİYATI
92.31.205	12	223,70 TL

Lüks Kuğu Eveye Bataryası



KOD	K.AD.	B.FİYATI
92.31.206	12	224,40 TL



ARMATÜR ÜRÜNLERİ

Hilal

Aplike Evye Bataryası



KOD	K.AD.	B.FİYATI
92.31.207	8	235,50 TL

Duş Bataryası



KOD	K.AD.	B.FİYATI
92.31.208	8	191,10 TL

Lüks Ay Kuğu Lavabo Bataryası



KOD	K.AD.	B.FİYATI
92.31.215	12	270,50 TL

Lüks Ay Kuğu Evye Bataryası



KOD	K.AD.	B.FİYATI
92.31.216	12	272,00 TL



ARMATÜR ÜRÜNLERİ

Arnika

Banyo Bataryası



KOD	K.AD.	B.FİYATI
92.42.101	12	241,40 TL

Lavabo Bataryası



KOD	K.AD.	B.FİYATI
92.42.102	12	219,10 TL

Ay Kuğu Lavabo Bataryası



KOD	K.AD.	B.FİYATI
92.42.115	12	163,10 TL

Ay Kuğu Evye Bataryası



KOD	K.AD.	B.FİYATI
92.42.116	12	163,90 TL

ARMATÜR ÜRÜNLERİ

Arnika

Aplike Evye Bataryası



KOD	K.AD.	B.FİYATI
92.42.107	8	218,60 TL

Duş Bataryası



KOD	K.AD.	B.FİYATI
92.42.108	8	171,50 TL

ARMATÜR ÜRÜNLERİ

Gülbahar

Tekli Kuğu



KOD	K.AD.	B.FİYATI
92.55.057	12	107,80 TL

Tekli Musluk



KOD	K.AD.	B.FİYATI
92.55.054	12	100,30 TL



ARMATÜR ÜRÜNLERİ

Gülnihal

Banyo Bataryası



KOD	K.AD.	B.FİYATI
92.42.201	12	212,10 TL

Lavabo Bataryası



KOD	K.AD.	B.FİYATI
92.42.202	12	200,90 TL

Kuşu Lavabo Bataryası



KOD	K.AD.	B.FİYATI
92.42.203	12	190,90 TL

Kuşu Eye Bataryası



KOD	K.AD.	B.FİYATI
92.42.204	12	192,30 TL

Kuşu Lavabo Bataryası



KOD	K.AD.	B.FİYATI
92.42.205	12	197,60 TL

Kuşu Eye Bataryası



KOD	K.AD.	B.FİYATI
92.42.206	12	199,10 TL



ARMATÜR ÜRÜNLERİ

Gülnihal

Aplike Bataryası



KOD	K.AD.	B.FİYATI
92.42.207	12	220,70 TL

Duş Bataryası



KOD	K.AD.	B.FİYATI
92.42.208	12	173,50 TL

Ay Kuğu Lavabo Bataryası



KOD	K.AD.	B.FİYATI
92.42.215	12	183,90 TL

Ay Kuğu Eveye Bataryası



KOD	K.AD.	B.FİYATI
92.42.216	12	187,80 TL

Su Arıtma Eveye Bataryası



KOD	K.AD.	B.FİYATI
92.42.222	12	653,00 TL

Çanak Lavabo Bataryası



KOD	K.AD.	B.FİYATI
92.42.217	12	326,70 TL



ARMATÜR ÜRÜNLERİ

Kardelen

Banyo Bataryası



KOD	K.AD.	B.FİYATI
92.31.701	12	196,50 TL

Lavabo Bataryası



KOD	K.AD.	B.FİYATI
92.31.702	12	171,40 TL

Kuşu Lavabo Bataryası



KOD	K.AD.	B.FİYATI
92.31.703	12	132,80 TL

Kuşu Eye Bataryası



KOD	K.AD.	B.FİYATI
92.31.704	12	132,80 TL



ARMATÜR ÜRÜNLERİ

Kardelen

Aplike Bataryası



KOD	K.AD.	B.FİYATI
92.31.707	12	225,30 TL

Duş Bataryası



KOD	K.AD.	B.FİYATI
92.31.708	12	182,50 TL

Döner Lavabo Bataryası



KOD	K.AD.	B.FİYATI
92.31.709	12	160,50 TL

Döner Eveye Bataryası



KOD	K.AD.	B.FİYATI
92.31.710	12	162,20 TL

Yarı Ankastre Banyo Bataryası



KOD	K.AD.	B.FİYATI
92.31.720	12	317,20 TL



ARMATÜR ÜRÜNLERİ

Nilüfer

Banyo Bataryası



KOD	K.AD.	B.FİYATI
92.41.301	12	180,10 TL

Lavabo Bataryası



KOD	K.AD.	B.FİYATI
92.41.302	12	151,50 TL

Kuşu Lavabo Bataryası



KOD	K.AD.	B.FİYATI
92.41.303	12	124,10 TL

Kuşu Eveye Bataryası



KOD	K.AD.	B.FİYATI
92.41.304	12	124,10 TL

Aplike Eveye Bataryası



KOD	K.AD.	B.FİYATI
92.41.307	12	207,20 TL

Duş Bataryası



KOD	K.AD.	B.FİYATI
92.41.308	12	162,70 TL



ARMATÜR ÜRÜNLERİ

Nilüfer

Döner Lavabo Bataryası - Profil



KOD	K.AD.	B.FİYATI
92.41.309	12	158,50 TL

Döner Evye Bataryası - Profil



KOD	K.AD.	B.FİYATI
92.41.310	12	159,20 TL

Yarı Ankastre Banyo Bataryası



KOD	K.AD.	B.FİYATI
92.41.320	12	294,40 TL



KOLAY VE HIZLI DEĐIŐİM

- ▶ Su tasarrufu ▶ Kolay montaj ▶ Akıllı sensör
- ▶ Pili. Elektrik tesisatına gerek yok
- ▶ Uzun süreli su akıtma

www.kas.com.tr

facebook.com/kasgrup
twitter.com/kasgrup_

KAS[®]

ARMATÜR ÜRÜNLERİ

Fotosel

Begonya Lavabo Bataryası



KOD	K.AD.	B.FİYATI
92.51.005	12	828,00 TL

35

Kamelya Lavabo Bataryası (ABS Gövde)



KOD	K.AD.	B.FİYATI
92.51.105	12	739,00 TL



ARMATÜR ÜRÜNLERİ

Kitchen

Endüstriyel

Çift Çıkışlı Eveye Bataryası



KOD	K.AD.	B.FİYATI
92.52.001	12	1.133,00 TL

Endüstriyel

Tek Çıkışlı Eveye Bataryası



KOD	K.AD.	B.FİYATI
92.52.002	12	685,00 TL

Hilal

Spiralli Kısa Eveye



KOD	K.AD.	B.FİYATI
92.31.220	12	545,00 TL

Hilal

Spiralli Eveye



KOD	K.AD.	B.FİYATI
92.31.221	12	509,00 TL

Spiralli Eveye Bataryası



KOD	K.AD.	B.FİYATI
92.52.003	12	655,00 TL

ARMATÜR ÜRÜNLERİ

Piramit

Banyo Bataryası



KOD	K.AD.	B.FİYATI
92.21.001	12	184,00 TL

Lavabo Bataryası



KOD	K.AD.	B.FİYATI
92.21.002	12	140,50 TL

Kuğu Eveye Bataryası



KOD	K.AD.	B.FİYATI
92.21.003	12	121,90 TL

Sabit Batarya



KOD	K.AD.	B.FİYATI
92.21.007	12	145,90 TL

Döner Lavabo Bataryası



KOD	K.AD.	B.FİYATI
92.21.004	12	132,00 TL

Döner Eveye Bataryası



KOD	K.AD.	B.FİYATI
92.21.005	12	148,70 TL

ARMATÜR ÜRÜNLERİ

Topaç

Banyo Bataryası



KOD	K.AD.	B.FİYATI
92.21.101	12	183,00 TL

Lavabo Bataryası



KOD	K.AD.	B.FİYATI
92.21.102	12	139,70 TL

Kuşu Eyme Bataryası



KOD	K.AD.	B.FİYATI
92.21.103	12	120,50 TL

Sabit Batarya



KOD	K.AD.	B.FİYATI
92.21.107	12	144,50 TL

Döner Lavabo Bataryası



KOD	K.AD.	B.FİYATI
92.21.104	12	130,70 TL

Döner Eyme Bataryası



KOD	K.AD.	B.FİYATI
92.21.105	12	147,30 TL

ARMATÜR ÜRÜNLERİ

Ankastre

Zaman Ayarlı Pisuvar Musluğu



KOD	K.AD.	B.FİYATI
92.81.005	8	129,60 TL

Ankastre

Pisuvar Musluğu



KOD	K.AD.	B.FİYATI
92.81.004	12	108,80 TL

Lüks Ankastre

Ankastre Aç- Kapa Musluk
(PPRC)

40



KOD	K.AD.	B.FİYATI
92.11.330 1/2"	36	61,50 TL
92.11.331 3/4"	36	64,20 TL

ARMATÜR ÜRÜNLERİ

Kumru Musluk

Topaç
Kısa Musluk



KOD	K.AD.	B.FİYATI
92.11.001	50	34,32 TL

Piramit
Kısa Musluk



KOD	K.AD.	B.FİYATI
92.11.101	50	36,04 TL

Topaç
Uzun Musluk



KOD	K.AD.	B.FİYATI
92.11.002	50	35,36 TL

Piramit
Uzun Musluk



KOD	K.AD.	B.FİYATI
92.11.102	50	37,46 TL

Topaç
Çamaşır Musluk



KOD	K.AD.	B.FİYATI
92.11.003	50	34,32 TL

Piramit
Çamaşır Musluk



KOD	K.AD.	B.FİYATI
92.11.103	50	36,04 TL

ARMATÜR ÜRÜNLERİ

Kumru Musluk

Aç - Kapa
Kısa Musluk



KOD	K.AD.	B.FİYATI
92.11.201	50	54,20 TL

Aç - Kapa
Uzun Musluk



KOD	K.AD.	B.FİYATI
92.11.202	50	54,90 TL

Aç - Kapa
Çamaşır Musluk



KOD	K.AD.	B.FİYATI
92.11.203	30	54,20 TL

Pirestij
Aç - Kapa Ankastr - PPRC 1/2"



KOD	K.AD.	B.FİYATI
92.11.335	50	76,50 TL

Topaç
Aç - Kapa Ankastr - PPRC



KOD	K.AD.	B.FİYATI	
92.11.312	1/2"	32	38,75 TL
92.11.314	3/4"	32	58,50 TL

Piramit
Aç - Kapa Ankastr - PPRC



KOD	K.AD.	B.FİYATI	
92.11.316	1/2"	32	39,43 TL
92.11.318	3/4"	32	59,30 TL

ARMATÜR ÜRÜNLERİ

Taharet Musluğu

Yıldız



KOD	K.AD.	B.FİYATI
92.11.305	50	19,97 TL

Piramit



KOD	K.AD.	B.FİYATI
92.11.302	50	27,25 TL

Topaç



KOD	K.AD.	B.FİYATI
92.11.301	50	25,44 TL

Aç - Kapa



KOD	K.AD.	B.FİYATI
92.11.332	3/8" 50	45,52 TL

Güneş



KOD	K.AD.	B.FİYATI
92.11.337	3/8" 50	19,26 TL

Yaprak

Aç - Kapa



KOD	K.AD.	B.FİYATI
92.11.347	3/8" 50	26,88 TL

ARMATÜR ÜRÜNLERİ

Taharet Musluğu

Beyaz Yıldız



KOD	K.AD.	B.FİYATI
92.11.343	50	17,12 TL

Papatya



KOD	K.AD.	B.FİYATI
92.11.345	50	16,40 TL

Küçük Yonca



KOD	K.AD.	B.FİYATI
92.11.303	50	17,85 TL

Prizma



KOD	K.AD.	B.FİYATI
92.11.304	50	20,78 TL

44

Çamaşır - Bulaşık Makinesi Musluğu



KOD	K.AD.	B.FİYATI
92.11.346	100	21,52 TL

Filtreli Taharet Musluğu



KOD	K.AD.	B.FİYATI
92.11.327	100	17,17 TL

ARMATÜR ÜRÜNLERİ

Yedek Parça



Yıldız Volan

KOD	K.AD.	B.FİYATI
91.10.123	50	18,00 TL



Yıldız Volan ve Salmastra

KOD	K.AD.	B.FİYATI
91.10.343	50	25,18 TL



Topaç Volan

KOD	K.AD.	B.FİYATI
91.10.121	50	8,32 TL



Topaç Volan ve Salmastra

KOD	K.AD.	B.FİYATI
91.10.341	50	15,65 TL



Piramit Volan

KOD	K.AD.	B.FİYATI
91.10.122	50	9,01 TL



Piramit Volan ve Salmastra

KOD	K.AD.	B.FİYATI
91.10.342	50	16,41 TL



Taharet Salmastrası

KOD	K.AD.	B.FİYATI
91.10.013	50	8,30 TL



35'lik Kısa Kartuş

KOD	K.AD.	B.FİYATI
91.10.232	50	23,79 TL



Aç - Kapa Salmastra

KOD	K.AD.	B.FİYATI
91.10.012	50	14,37 TL



35'lik Ayaklı Kartuş

KOD	K.AD.	B.FİYATI
91.10.231	50	23,39 TL



Salmastra

KOD	K.AD.	B.FİYATI
91.10.011	50	9,75 TL



40'lik Kısa Kartuş

KOD	K.AD.	B.FİYATI
91.10.233	50	23,86 TL



Taharat Volan

KOD	K.AD.	B.FİYATI
91.10.124	50	3,72 TL



40'lik Ayaklı Kartuş

KOD	K.AD.	B.FİYATI
91.10.234	50	23,86 TL

ANKASTRE DUŞ SETLERİ

Ankastre Banyo
Üç Yönlü Banyo Bataryası

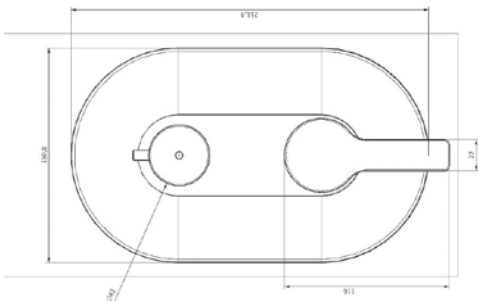
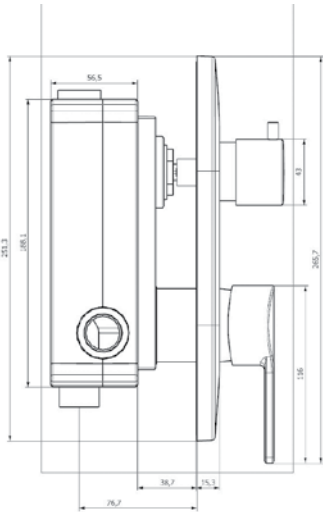

KOD	K.AD.	B.FİYATI
92.81.103	8	905,00 TL

Özellikler

- PP-R gövde yapısına sahiptir.
- PP-R plastik boru ile birleştirmek için herhangi bir ek malzemeye ihtiyaç duyulmaz.
- Maliyeti düşük ve işçiliği kolaydır.

PANEL DUŞ SETLERİ

İnci

KOD	K.AD.	B.FİYATI
91.30.510	1	1.946,00 TL



- 304 Kalite kromlu paslanmaz çelik gövde (1.50 cm / 20 em)
- Pirinç musluk
- 150 cm den 180 cm ye uzayabilen, çift kenetli, EPDM iç hortumu, uçları ve somunları pirinç, kromlu paslanmaz çelik duş hortumu
- Pirinç dağıtıcı valf
- 1. Kalite paslanmaz çelik flex hortum
- 4 fonksiyonlu musluk

TEPE DUŞ SETLERİ

Elmas

KOD	K.AD.	B.FİYATI
91.30.310	8	233,20 TL

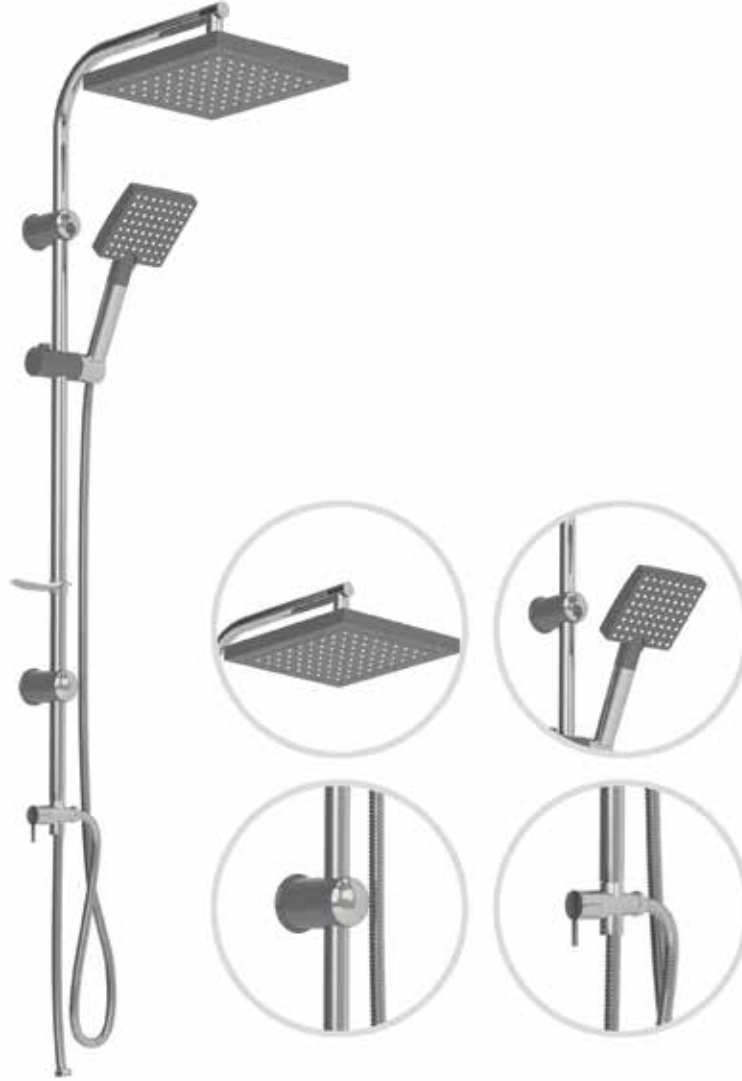

48

- Kromlu paslanmaz çelik boru
- Kromlu ABS fonksiyonel el duşu
- 150 cm. den 180 cm. ye uzayabilen, çift kenetli, EPDM iç hortumu, uçları ve somunları pirinç, paslanmaz çelik duş hortumu.
- Krom kaplama ABS kurulum ekipmanları
- Sürgü sistemiyle kolay kullanım imkanı

TEPE DUŞ SETLERİ

Kuartz

KOD	K.AD.	B.FİYATI
91.30.010	8	230,60 TL



- Kromlu paslanmaz çelik boru
- Kromlu ABS fonksiyonel el duşu
- 150 cm. den 180 cm. ye uzayabilen, çift kenetli, EPDM iç hortumu, uçları ve somunları pirinç, paslanmaz çelik duş hortumu.
- Krom kaplama ABS kurulum ekipmanları
- Sürgü sistemiyle kolay kullanım imkanı

TEPE DUŞ SETLERİ

Safir

KOD	K.AD.	B.FİYATI
91.30.410	8	297,50 TL



50

- Kromlu paslanmaz çelik boru
- Kromlu ABS fonksiyonel el duşu
- 150 cm. den 180 cm. ye uzayabilen, çift kenetli, EPDM iç hortumu, uçları ve somunları pirinç, paslanmaz çelik duş hortumu.
- Krom kaplama ABS kurulum ekipmanları
- Sürgü sistemiyle kolay kullanım imkanı

TEPE DUŞ SETLERİ

Yakut

KOD	K.AD.	B.FİYATI
91.30.210	8	226,20 TL



- Kromlu paslanmaz çelik boru
- Kromlu ABS fonksiyonel el duşu
- 150 cm. den 180 cm. ye uzayabilen, çift kenetli, EPDM iç hortumu, uçları ve somunları pirinç, paslanmaz çelik duş hortumu.
- Krom kaplama ABS kurulum ekipmanları
- Sürgü sistemiyle kolay kullanım imkanı

TEPE DUŞ SETLERİ

Zümrüt

KOD	K.AD.	B.FİYATI
91.30.110	8	194,30 TL



52

- Kromlu paslanmaz çelik boru
- Kromlu ABS fonksiyonel el duşu
- 150 cm. den 180 cm. ye uzayabilen, çift kenetli, EPDM iç hortumu, uçları ve somunları pirinç, paslanmaz çelik duş hortumu.
- Krom kaplama ABS kurulum ekipmanları
- Sürgü sistemiyle kolay kullanım imkanı

SÜRGÜLÜ DUŞ SETLERİ



53

Elmas

KOD	K.AD.	B.FİYATI
91.30.320	20	71,80 TL

Kvartz

KOD	K.AD.	B.FİYATI
91.30.020	20	70,00 TL

SÜRGÜLÜ DUŞ SETLERİ

54

**Yakut**

KOD	K.AD.	B.FİYATI
91.30.220	20	68,60 TL

**Zümrüt**

KOD	K.AD.	B.FİYATI
91.30.120	20	48,54 TL

SÜRGÜLÜ DUŞ SETLERİ



55

Safir

KOD	K.AD.	B.FİYATI
91.30.420	20	108,30 TL

MAFSALLI DUŞ SETLERİ

Elmas



KOD	K.AD.	B.FİYATI
91.30.330	28	43,05 TL

Kuartz



KOD	K.AD.	B.FİYATI
91.30.030	28	42,52 TL

Safir



KOD	K.AD.	B.FİYATI
91.30.430	28	69,20 TL

Yakut



KOD	K.AD.	B.FİYATI
91.30.230	28	41,98 TL

Zümrüt



KOD	K.AD.	B.FİYATI
91.30.130	28	29,21 TL

Yağmur
Ankastre Duş



KOD	K.AD.	B.FİYATI
91.10.810	12	63,40 TL

YENİLENEN GÖVDESİYLE ŞİMDİ ÇOK DAHA GÜÇLÜ, DAYANIKLI ve UZUN ÖMÜRLÜ.



AÇIKLIK PAYI

Duvara montaj sonrası
kolun çalışmasına engel
olmayacak yeterli
açıklık

VİDASIZ TASARIM

Patentli klik geçme tasarım
vida paslanması, vidanın
gövdeye kayması
sorunlarına son

ÇİFT CONTA

Çift conta ile
kuvvetlendirilmiş
sızdırmazlık uzun
ömürlü yüksek
dayanım

PASLANMAZ FİLTRE

Çift taraflı yataklanmış gerçek
paslanmazlık özelliğine sahip
304 kaliteli malzemen
tıkanma ve bakım zamanını
uzatan, uzun ve büyük
filtre

TEFLON

PTFE (Teflon)
sızdırmazlık
elemanı ile uzun ömür,
yüksek dayanım,
1. sınıf sızdırmazlık.

PİRİNÇ GÖVDE

Tamamı avrupa normunda
pirinç malzemen
yapılmış gövde ve
parçaları

ANAHTAR AĞIZI

Ürüne zarar vermeden
montaj imkanı veren
anahtar ağzı

ERGONOMİK TASARIM

3 barda 35 lt/dk çıkış
sağlayan ergonomik
tasarım

FİLTRE YUVASI

Su akışına engel olmayan
geniş filtre yuvası

Yeni Termostatik Radyatör Vanası

Şimdi KAS üretimiyle

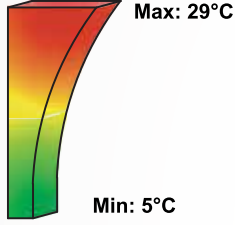

Su ve Doğalgaz Tesisat Ürünleri



SU ve DOĞALGAZ TESİSAT ÜRÜNLERİ

Gaz Küresel Vana

(Mob 5 - 20) Tam Geçişli

 EN 331



KOD	AÇIKLAMA	K.AD.	B.FİYATI
07.01.400	1/2"	100	19,10
07.01.401	3/4"	80	28,20
07.01.402	1"	40	44,38
07.01.403	1 1/4"	20	67,30
07.01.404	1 1/2"	12	113,00
07.01.405	2"	8	161,50

Gaz Küresel Vana

(Mob 5 - 20) Tam Geçişli - Kilitli

 EN 331



KOD	AÇIKLAMA	K.AD.	B.FİYATI
07.02.400	1/2"	100	19,60 TL
07.02.401	3/4"	80	28,76 TL
07.02.402	1"	40	45,29 TL

Gaz Küresel Vana

(Mob 5) Tam Geçişli

 EN 331



KOD	AÇIKLAMA	K.AD.	B.FİYATI
07.04.400	1/2"	100	17,03 TL
07.04.401	3/4"	80	24,04 TL
07.04.402	1"	40	42,28 TL
07.04.403	1 1/4"	20	61,00 TL
07.04.404	1 1/2"	12	95,80 TL
07.04.405	2"	8	146,80 TL

Gaz Küresel Vana

(Mob 5) Tam Geçişli - Kilitli

 EN 331



KOD	AÇIKLAMA	K.AD.	B.FİYATI
07.05.400	1/2"	100	17,20 TL
07.05.401	3/4"	80	24,50 TL
07.05.402	1"	40	42,83 TL

SU ve DOĞALGAZ TESİSAT ÜRÜNLERİ

Su Küresel Vana

(PN 10) Tam Geçişli - İçme Suyu

 EN 13828



KOD	AÇIKLAMA	K.AD.	B.FİYATI
08.01.330	1/2"	100	19,10 TL
08.01.331	3/4"	80	28,20 TL
08.01.332	1"	40	44,40 TL
08.01.333	1 1/4"	20	73,20 TL
08.01.334	1 1/2"	12	118,90 TL
08.01.335	2"	8	175,10 TL

Su Küresel Vana

(PN 40) Tam Geçişli

 EN 13547



KOD	AÇIKLAMA	K.AD.	B.FİYATI
08.02.420	1/2"	100	19,10 TL
08.02.421	3/4"	80	28,20 TL
08.02.422	1"	40	44,40 TL
08.02.423	1 1/4"	20	67,30 TL
08.02.424	1 1/2"	12	113,00 TL
08.02.425	2"	8	164,00 TL

Su Küresel Vana

(PN 25) Tam Geçişli

 EN 13547



KOD	AÇIKLAMA	K.AD.	B.FİYATI
08.09.430	1/2"	100	17,03 TL
08.09.431	3/4"	80	24,04 TL
08.09.432	1"	40	42,28 TL
08.09.433	1 1/4"	20	61,00 TL
08.09.434	1 1/2"	12	95,80 TL
08.09.435	2"	8	146,80 TL

Su Küresel Vana

(PN 16) Tam Geçişli

 CEN 13547



KOD	AÇIKLAMA	K.AD.	B.FİYATI
80.61.426	2 1/2"	4	522,00 TL
80.61.427	3"	3	712,00 TL
80.61.428	4"	2	1.356,00 TL

SU ve DOĞALGAZ TESİSAT ÜRÜNLERİ

Su Küresel Vana

(PN 40) Tam Geçişli - Kelebek Kollu



KOD	AÇIKLAMA	K.AD.	B.FİYATI
08.03.325	1/2" Dış Dişli	100	20,97 TL
08.03.326	3/4" Dış Dişli	80	30,42 TL
08.03.327	1" Dış Dişli	40	43,86 TL
08.04.325	1/2" İç Dişli	100	20,00 TL
08.04.326	3/4" İç Dişli	80	29,39 TL
08.04.327	1" İç Dişli	40	44,15 TL

Su Küresel Vana

(PN 25) Tam Geçişli - Kelebek Kollu



KOD	AÇIKLAMA	K.AD.	B.FİYATI
08.03.430	1/2" Dış Dişli	100	18,85 TL
08.03.431	3/4" Dış Dişli	80	26,15 TL
08.03.432	1" Dış Dişli	40	42,71 TL
08.04.430	1/2" İç Dişli	100	17,70 TL
08.04.431	3/4" İç Dişli	80	24,38 TL
08.04.432	1" İç Dişli	40	43,18 TL

Su Küresel Vana

(PN 40) Kelebek Kollu



KOD	AÇIKLAMA	K.AD.	B.FİYATI
08.03.530	1/2" Dış Dişli	100	15,62 TL
08.03.531	3/4" Dış Dişli	80	22,64 TL
08.04.530	1/2" İç Dişli	100	14,59 TL
08.04.531	3/4" İç Dişli	80	22,49 TL

Su Küresel Vana

(PN 40) Tam Geçişli - Rakorlu - Kelebek Kollu



KOD	AÇIKLAMA	K.AD.	B.FİYATI
08.05.325	1/2"	60	28,47 TL
08.05.326	3/4"	50	43,40 TL
08.08.327	1"	40	47,51 TL
08.05.328	1 1/4"	20	91,90 TL

SU ve DOĞALGAZ TESİSAT ÜRÜNLERİ

Sensör Kovanlı Küresel Vana
(PN 40) Tam Geçişli - Kelebek Kollu



KOD	AÇIKLAMA	K.AD.	B.FİYATI
08.07.327	1" Rakorlu	40	59,10 TL

Su Küresel Vana
(PN 40) Tam Geçişli Rakorlu - Kelebek Kollu



KOD	AÇIKLAMA	K.AD.	B.FİYATI
08.06.327	1" Contalı Masura	40	63,80 TL

Yangın Rakorlu Küresel Vana
(PN 40)



KOD	AÇIKLAMA	K.AD.	B.FİYATI
08.11.327	1"	40	70,80 TL

Filtreli Küresel Vana
(PN 40)



KOD	AÇIKLAMA	K.AD.	B.FİYATI
08.08.448	1/2"	60	39,73 TL
08.08.449	3/4"	50	56,30 TL

SU ve DOĞALGAZ TESİSAT ÜRÜNLERİ

Filtreli Musluk (PN 10)



KOD	AÇIKLAMA	K.AD.	B.FİYATI
01.07.174	1/2" - 3/8" Taharat Musl.	160	15,35 TL
01.06.173	Çamaşır - Bulaşık Mak. Mus.	100	21,02 TL

Küresel (PN 10) Pirinç Rakorlu



KOD	AÇIKLAMA	K.AD.	B.FİYATI
09.03.922	3/4" Rakor 3/4" Bağlantı	50	30,57 TL
09.04.922	3/4" Rakor 3/4" Bağ. Kelebek Kol	50	30,72 TL
09.06.921	1/2" Tek Parça Rakorlu	50	24,90 TL
09.07.921	1/2" Kelebek Kol - Tek Parça Rakorlu	50	24,98 TL

64

Küresel Bas (PN 10)



KOD	AÇIKLAMA	K.AD.	B.FİYATI
10.01.370	3/4"	50	29,92 TL
10.01.371	3/4" Paslanmaz Kol*	50	37,51 TL

(* Kol ve somun nemli ortamlarda kullanıma uygun paslanmaz çelikten (AISI 304) imal edilmiştir.

Talep edildiği takdirde kelebek kollu olarak imal edilebilir.

Mini Küresel Vana

TSEK



KOD	AÇIKLAMA	K.AD.	B.FİYATI
05.03.322	1/2"	200	12,60 TL
05.03.323	3/4"	120	17,85 TL

SU ve DOĞALGAZ TESİSAT ÜRÜNLERİ

Çalparalı (Yatay) Çekvalf



KOD	AÇIKLAMA	K.AD.	B.FİYATI
80.82.460	1/2"	100	20,19 TL
80.82.461	3/4"	75	26,90 TL
80.82.462	1"	50	41,76 TL
80.82.463	1 1/4"	50	60,20 TL
80.82.464	1 1/2"	40	81,30 TL
80.82.465	2"	15	118,50 TL
80.82.466	2 1/2"	10	211,70 TL
80.82.467	3"	6	252,80 TL

Yaylı (Dik) Çekvalf - Sessiz



KOD	AÇIKLAMA	K.AD.	B.FİYATI
80.81.470	1/2"	100	18,34 TL
80.81.471	3/4"	75	23,98 TL
80.81.472	1"	50	33,59 TL
80.81.473	1 1/4"	50	54,40 TL
80.81.474	1 1/2"	40	71,70 TL
80.81.475	2"	24	103,90 TL
80.81.456	2 1/2"	12	231,30 TL
80.81.457	3"	6	270,40 TL

65

Doğalgaz Filtresi - U Manometre



KOD	AÇIKLAMA	K.AD.	B.FİYATI
80.32.820	1/2" Gaz Filtresi	70	40,31 TL
11.03.821	3/4" Gaz Filtresi	70	25,13 TL
70.02.470	U Manometre	25	80,60 TL
70.03.800	Doğalgaz Tesisat Macunu	24	11,97 TL

Flatör - Paslanmaz Memeli



KOD	AÇIKLAMA	K.AD.	B.FİYATI
80.71.540	1/2"	50	24,58 TL
80.71.541	3/4"	50	28,48 TL
80.71.542	1"	50	31,81 TL
80.71.543	1 1/4"	20	90,50 TL
80.71.544	1 1/2"	20	97,40 TL
80.71.545	2"	20	105,90 TL

SU ve DOĞALGAZ TESİSAT ÜRÜNLERİ

Filtre (Pislik Tutucu)

TSEK



KOD	AÇIKLAMA	K.AD.	B.FİYATI
12.02.340	1/2" Yeni Tasarım	150	12,77 TL
12.02.341	3/4" Yeni Tasarım	80	18,32 TL
12.02.342	1" Yeni Tasarım	50	30,10 TL
12.01.340	1/2"	150	17,35 TL
12.01.341	3/4"	80	25,10 TL
12.01.342	1"	50	36,18 TL
80.31.343	1 1/4"	30	65,50 TL
80.31.344	1 1/2"	20	89,50 TL
80.31.345	2"	10	141,20 TL
80.31.346	2" 1/2"	8	225,60 TL
80.31.347	3"	6	302,90 TL
80.31.348	4"	4	573,00 TL

Uzatma Grubu



KOD	AÇIKLAMA	K.AD.	B.FİYATI
80.04.160	1/2" - 3/4" Bas Uzatma	250	6,50 TL
80.04.175	3/4" Düz Batarya Uzatması	100	18,67 TL
80.04.176	3/4" Delikli Batarya Uzatması	100	19,94 TL
80.04.180	1/2" Bulaşık Makinası Uzatması	100	19,51 TL
80.04.185	3/4" Çamaşır Musluk Çatalı	100	18,67 TL

66

Uzatma (25 mm)



KOD	AÇIKLAMA	K.AD.	B.FİYATI
80.01.101	1/2" 1 cm	500	3,69 TL
80.01.102	1/2" 1,5 cm	400	4,58 TL
80.01.103	1/2" 2 cm	300	5,37 TL
80.01.104	1/2" 2,5 cm	250	6,18 TL
80.01.105	1/2" 3 cm	200	7,19 TL
80.01.106	1/2" 4 cm	175	12,90 TL
80.01.107	1/2" 5 cm	150	14,02 TL

Şiber Vana

TSE EN 12288



KOD	AÇIKLAMA	K.AD.	B.FİYATI
11.01.850	1/2"	60	27,00 TL
11.01.851	3/4"	50	28,33 TL
11.01.852	1"	30	50,50 TL

SU ve DOĞALGAZ TESİSAT ÜRÜNLERİ

Rakorlar



KOD	AÇIKLAMA	K.AD.	B.FİYATI
80.23.241	1/2" Hortum Rakoru	500	4,80 TL
80.23.242	3/4" Hortum Rakoru	300	5,60 TL
80.23.243	1" Hortum Rakoru	150	8,80 TL
80.23.244	1 1/4" Hortum Rakoru	100	14,45 TL
80.23.245	1 1/2" Hortum Rakoru	75	19,25 TL
80.23.246	2" Hortum Rakoru	40	31,25 TL
80.22.191	3/4" Su Saati Rakoru	100	11,40 TL

Stop Vana



KOD	AÇIKLAMA	K.AD.	B.FİYATI
11.02.850	1/2"	60	32,39 TL
11.02.851	3/4"	50	28,90 TL
11.02.852	1"	30	63,00 TL

Nipel - Kromlu



KOD	AÇIKLAMA	K.AD.	B.FİYATI
02.02.200	3/8"	500	2,73 TL
02.02.201	1/2"	250	4,97 TL
02.02.202	3/4"	200	7,27 TL
02.02.203	1"	100	13,72 TL

Orantılı Nipel - Redüksiyon



KOD	AÇIKLAMA	K.AD.	B.FİYATI
02.03.210	3/8" - 1/2" Orantılı Nipel	300	4,87 TL
02.03.211	1/2" - 3/4" Orantılı Nipel	250	5,66 TL
02.03.212	3/4" - 1" Orantılı Nipel	100	13,72 TL
02.01.195	3/8" - 1/2" Redüksiyon	500	4,03 TL
02.01.196	1/2" - 3/4" Redüksiyon	300	5,11 TL

SU ve DOĞALGAZ TESİSAT ÜRÜNLERİ

Köşe Termostatik Radyatör Vanası (Jaklı)

 TS EN 215

Yeni
ürün



KOD	AÇIKLAMA	K.AD.	B.FİYATI
13.50.001	1/2"	30	47,11 TL
13.50.002	1/2" Pex-B	30	50,80 TL

Köşe Termostatik Radyatör Vanası PVC Volan

 TS EN 215



KOD	AÇIKLAMA	K.AD.	B.FİYATI
13.40.001	1/2"	30	53,00 TL
13.40.014	1/2" Pex-B	30	57,80 TL

* 15°C Sabitleme yapılabilir.

* 15°C Sabitleme yapılabilir.

Köşe Termostatik Radyatör Vanası Kromlu Volan

 TS EN 215



KOD	AÇIKLAMA	K.AD.	B.FİYATI
13.01.002	1/2"	30	111,80 TL
13.14.014	1/2" Pex-B	30	127,10 TL

* 15°C Sabitleme yapılabilir.

Köşe Termostatik Radyatör Vanası PVC Volan

 TS EN 215



KOD	AÇIKLAMA	K.AD.	B.FİYATI
13.02.001	1/2"	30	52,90 TL
13.15.014	1/2" Pex-B	30	57,80 TL

* 15°C Sabitleme yapılabilir.

SU ve DOĞALGAZ TESİSAT ÜRÜNLERİ

Eksenel Termostatik Vanası

 TS EN 215



KOD	AÇIKLAMA	K.AD.	B.FİYATI
13.09.007	1/2" PVC Volan	30	71,10 TL
13.10.018	1/2" Kromlu Volan	30	127,70 TL

* 15°C Sabitleme yapılabilir.

Düz Termostatik Radyatör Vanası

 TS EN 215



KOD	AÇIKLAMA	K.AD.	B.FİYATI
13.03.014	1/2" Kromlu Volan	30	115,50 TL
13.04.009	1/2" PVC Volan	30	67,70 TL

* 15°C Sabitleme yapılabilir.

Köşe Radyatör Vanası (KV3)

 TS 579



KOD	AÇIKLAMA	K.AD.	B.FİYATI
04.07.303	1/2"	30	26,38 TL

Köşe Radyatör Vanası Pex-B Bağlantılı (KV3)

 TS 579



KOD	AÇIKLAMA	K.AD.	B.FİYATI
04.07.308	1/2"	50	29,91 TL

SU ve DOĞALGAZ TESİSAT ÜRÜNLERİ

Köşe Radyatör Vanası (KV3)

 TS 579



KOD	AÇIKLAMA	K.AD.	B.FİYATI
04.01.303	1/2"	50	18,94 TL
04.05.310	3/4"	50	30,36 TL
04.08.303	1/2" Contalı Masura	50	26,21 TL
04.06.310	3/4" Contalı Masura	50	31,88 TL

Köşe Radyatör Vanası (KV4)

 TS 579



KOD	AÇIKLAMA	K.AD.	B.FİYATI
04.01.307	1/2"	50	16,92 TL

70

Köşe Radyatör Vanası Pex-B Bağlantılı (KV3)

 TS 579



KOD	AÇIKLAMA	K.AD.	B.FİYATI
04.01.308	1/2"	50	21,93 TL
04.08.308	1/2" Contalı Masura	50	28,49 TL

Köşe Radyatör Vanası Pex-B Bağlantılı (KV4)

 TS 579



KOD	AÇIKLAMA	K.AD.	B.FİYATI
04.01.309	1/2"	50	20,00 TL

SU ve DOĞALGAZ TESİSAT ÜRÜNLERİ

Köşe Radyatör Vanası Bakır Boru Bağlantılı (KV3)

 TS 579



KOD	AÇIKLAMA	K.AD.	B.FİYATI
04.01.304	1/2"	50	25,52 TL

Düz Radyatör Vanası (KV3)

 TS 579



KOD	AÇIKLAMA	K.AD.	B.FİYATI
04.02.301	1/2"	50	23,57 TL
04.05.311	3/4"	50	34,97 TL
04.08.301	1/2" Contalı Masura	50	27,59 TL
04.06.311	3/4" Contalı Masura	50	40,14 TL

Köşe Geri Dönüş Vanası (KV3)

 TS 579



KOD	AÇIKLAMA	K.AD.	B.FİYATI
04.04.303	1/2" Köşe	100	17,60 TL
04.04.308	1/2" Köşe Pex-B	100	22,97 TL
04.03.301	1/2" Düz	100	23,65 TL

Düz - Köşe Rakor

 TS 579



KOD	AÇIKLAMA	K.AD.	B.FİYATI
03.01.250	1/2" Düz	150	13,19
03.01.251	3/4" Düz	90	19,20
03.01.252	1" Düz	50	28,92
03.02.260	1/2" Köşe	150	16,02
03.02.261	3/4" Köşe	100	23,75
03.02.262	1" Köşe	50	39,05

SU ve DOĞALGAZ TESİSAT ÜRÜNLERİ

Diyaframlı Basınç Düşürücü - Manometreli

 TS EN 1567



KOD	AÇIKLAMA	K.AD.	B.FİYATI
71.07.580	1/2"	25	132,60 TL
71.07.581	3/4"	25	135,00 TL
71.07.582	1"	10	177,30 TL
71.08.570	1/2" Rakorlu	25	145,80 TL
71.08.571	3/4" Rakorlu	25	155,60 TL

Diyaframlı Basınç Düşürücü

 TS EN 1567



KOD	AÇIKLAMA	K.AD.	B.FİYATI
71.09.590	1/2"	25	102,00 TL
71.09.591	3/4"	25	105,80 TL
71.09.592	1"	10	148,00 TL
71.10.560	1/2" Rakorlu	10	116,40 TL
71.10.561	3/4" Rakorlu	10	125,10 TL

Basınç Düşürücü - Manometreli

 TS EN 1567



KOD	AÇIKLAMA	K.AD.	B.FİYATI
71.04.580	1/2"	18	118,20 TL
71.04.581	3/4"	18	121,10 TL
71.04.582	1"	10	245,70 TL
71.04.583	1 1/4"	10	317,90 TL
71.04.584	1 1/2"	10	346,50 TL
71.04.585	2"	10	439,00 TL
71.04.586	2 1/2"	1	902,00 TL
71.04.587	3"	1	1.151,00 TL
71.03.570	1/2" Rakorlu	18	128,20 TL
71.03.571	3/4" Rakorlu	18	135,00 TL

Basınç Düşürücü

 TS EN 1567



KOD	AÇIKLAMA	K.AD.	B.FİYATI
71.05.590	1/2"	25	88,80 TL
71.05.591	3/4"	25	91,70 TL
71.05.592	1"	10	216,20 TL
71.05.593	1 1/4"	10	288,60 TL
71.05.594	1 1/2"	10	317,30 TL
71.05.595	2"	10	409,00 TL
71.05.596	2 1/2"	1	873,00 TL
71.05.597	3"	1	1.121,00 TL
71.02.560	1/2" Rakorlu	25	98,70 TL
71.02.561	3/4" Rakorlu	25	105,80 TL

SU ve DOĞALGAZ TESİSAT ÜRÜNLERİ

Diyaframlı Emniyet Ventili - Dış Diş



KOD	AÇIKLAMA	K.AD.	B.FİYATI
71.06.600	1/2" (2,5-3-4-5-6 Bar)	25	24,02 TL
71.06.601	1/2" (7-8-9-10 Bar)	25	25,81 TL
71.06.602	3/4" (2,5-3-4-5-6 Bar)	25	48,42 TL
71.06.603	3/4" (7-8-9-10 Bar)	25	51,10 TL
71.06.604	1" (2,5-3-4-5-6 Bar)	10	74,10 TL
71.06.605	1" (7-8-9-10 Bar)	10	78,20 TL

Diyaframlı Emniyet Ventili - İç Diş



KOD	AÇIKLAMA	K.AD.	B.FİYATI
71.06.610	1/2" (2,5-3-4-5-6 Bar)	25	24,02 TL
71.06.611	1/2" (7-8-9-10 Bar)	25	25,81 TL
71.06.612	3/4" (2,5-3-4-5-6 Bar)	25	48,22 TL
71.06.613	3/4" (7-8-9-10 Bar)	25	51,10 TL
71.06.614	1" (2,5-3-4-5-6 Bar)	10	72,10 TL
71.06.615	1" (7-8-9-10 Bar)	10	76,20 TL
71.06.616	1 1/4" (2,5-3-4-5-6 Bar)	5	212,70 TL
71.06.617	1 1/4" (7-8-9-10 Bar)	5	223,40 TL
71.06.618	1 1/2" (2,5-3-4-5-6 Bar)	1	879,00 TL
71.06.619	1 1/2" (7-8-9-10 Bar)	1	938,00 TL
71.06.620	2" (2,5-3-4-5-6 Bar)	1	1,141,00 TL
71.06.621	2" (7-8-9-10 Bar)	1	1,216,00 TL

Emniyet Ventili - Dış Diş



KOD	AÇIKLAMA	K.AD.	B.FİYATI
71.01.508	1/2"	250	20,52 TL
71.01.509	1/2" Mandallı	250	22,63 TL

Kör Tapa



KOD	AÇIKLAMA	K.AD.	B.FİYATI
46.08.007	1 1/4" 14 İnce Diş	100	7,91 TL
46.08.008	1 1/4" 11 Kalın Diş	100	5,97 TL

KAS Kollektörde YENİLİK var !

KAS AR-GE ekibimizin, kaliteden ödün vermeyen **inovasyon** anlayışı sonucu tasarladığı, yeni bir **teknoloji** ile ürettiğimiz, **patentli** ürünümüzle **işinizi kolaylaştırmaya devam ediyoruz.**

Üstelik şaşırtan fiyatlarla...

Paslanmaz Çelik Kollektör

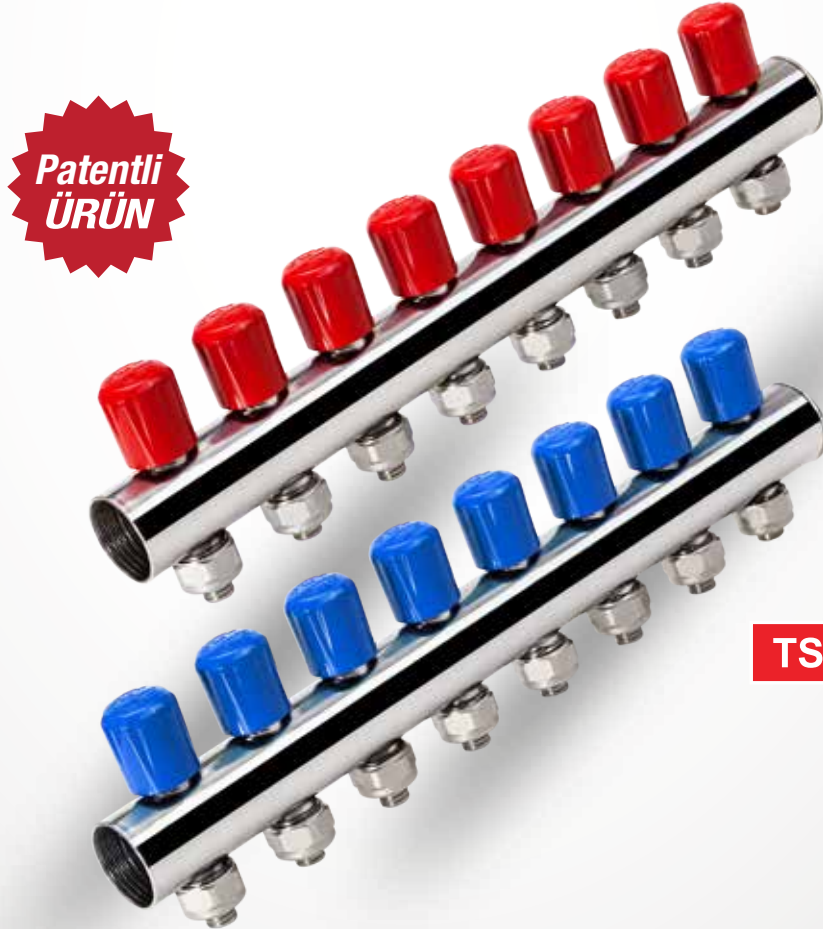

Kollektör ve Yerden Isıtma Grubu

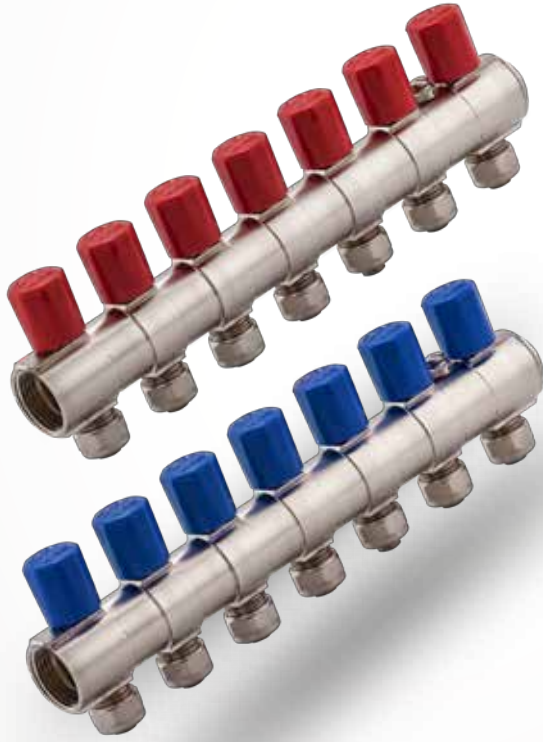

KOLLEKTÖR ve YERDEN ISITMA GRUPLARI

1" Paslanmaz Çelik Kollektör (PN 10)

TSEK

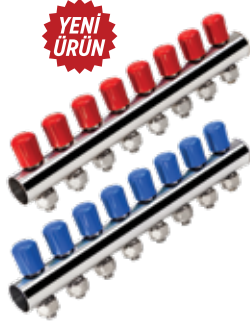

KOD	AÇIKLAMA	K.AD.	B. FİYATI
18.17.682	2 Delikli	30	50,20 TL
18.17.683	3 Delikli	20	68,50 TL
18.17.684	4 Delikli	20	86,80 TL
18.17.685	5 Delikli	20	105,70 TL
18.17.686	6 Delikli	10	123,90 TL
18.17.687	7 Delikli	10	142,50 TL
18.17.688	8 Delikli	10	160,70 TL
18.17.689	9 Delikli	10	177,40 TL
18.17.690	10 Delikli	10	197,50 TL

1" Vanalı Kollektör (PN 10)

TSEK



KOD	AÇIKLAMA	K.AD.	B. FİYATI
18.01.582	2 Delikli	30	59,90 TL
18.01.583	3 Delikli	20	84,80 TL
18.01.584	4 Delikli	20	109,60 TL
18.01.585	5 Delikli	20	134,50 TL
18.01.586	6 Delikli	10	159,10 TL
18.01.587	7 Delikli	10	183,50 TL
18.01.588	8 Delikli	10	208,60 TL
18.01.589	9 Delikli	10	233,00 TL
18.01.590	10 Delikli	10	259,00 TL
18.01.591	11 Delikli	10	284,10 TL
18.01.592	12 Delikli	10	312,30 TL
18.01.593	13 Delikli	10	336,40 TL

76

1" Termostatik Kollektör (PN 10)



KOD	AÇIKLAMA	K.AD.	B. FİYATI
18.16.502	2 Delikli	-	132,80 TL
18.16.503	3 Delikli	-	196,90 TL
18.16.504	4 Delikli	-	261,70 TL
18.16.505	5 Delikli	-	327,50 TL
18.16.506	6 Delikli	-	392,00 TL
18.16.507	7 Delikli	-	457,00 TL
18.16.508	8 Delikli	-	523,00 TL
18.16.509	9 Delikli	-	587,00 TL
18.16.510	10 Delikli	-	653,00 TL
18.16.511	11 Delikli	-	720,00 TL
18.16.512	12 Delikli	-	788,00 TL
18.16.513	13 Delikli	-	856,00 TL

1" Debili Kollektör (PN 10)

TSEK



KOD	AÇIKLAMA	K.AD.	B. FİYATI
18.15.502	2 Delikli	-	153,80 TL
18.15.503	3 Delikli	-	223,80 TL
18.15.504	4 Delikli	-	292,80 TL
18.15.505	5 Delikli	-	362,70 TL
18.15.506	6 Delikli	-	431,00 TL
18.15.507	7 Delikli	-	501,00 TL
18.15.508	8 Delikli	-	570,00 TL
18.15.509	9 Delikli	-	640,00 TL
18.15.510	10 Delikli	-	709,00 TL
18.15.511	11 Delikli	-	780,00 TL
18.15.512	12 Delikli	-	852,00 TL
18.15.513	13 Delikli	-	925,00 TL

KOLLEKTÖR ve YERDEN ISITMA GRUPLARI

1" Vanalı Kollektör (Ağır Tip) (PN 10)

TSEK



KOD	AÇIKLAMA	K.AD.	B.FİYATI
18.01.482	2 Delikli	30	63,00 TL
18.01.483	3 Delikli	20	90,30 TL
18.01.484	4 Delikli	20	118,20 TL
18.01.485	5 Delikli	20	144,80 TL
18.01.486	6 Delikli	10	173,90 TL
18.01.487	7 Delikli	10	202,00 TL
18.01.488	8 Delikli	10	228,20 TL
18.01.489	9 Delikli	10	256,00 TL
18.01.490	10 Delikli	10	284,50 TL
18.01.491	11 Delikli	10	314,50 TL
18.01.492	12 Delikli	10	342,00 TL
18.01.493	13 Delikli	10	370,00 TL

1 1/4" Vanalı Kollektör (PN 10)

TSEK

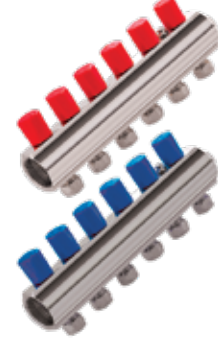

KOD	AÇIKLAMA	K.AD.	B.FİYATI
18.03.703	3 Delikli	16	134,70 TL
18.03.704	4 Delikli	16	170,80 TL
18.03.705	5 Delikli	16	211,50 TL
18.03.706	6 Delikli	8	252,30 TL
18.03.707	7 Delikli	8	288,70 TL
18.03.708	8 Delikli	8	327,50 TL
18.03.709	9 Delikli	8	365,80 TL
18.03.710	10 Delikli	8	408,00 TL
18.03.711	11 Delikli	8	451,00 TL
18.03.712	12 Delikli	8	489,00 TL
18.03.713	13 Delikli	8	528,00 TL

77

Purjör - Test Nipelini



KOD	AÇIKLAMA	K.AD.	B.FİYATI
80.57.507	1/2" Otomatik Purjör	76	24,30 TL
80.51.550	Test Nipelini	1000	2,47 TL

Tahliye Musluğu



KOD	AÇIKLAMA	K.AD.	B.FİYATI
18.09.350	Manuel Purjör	-	48,05 TL
18.09.351	Otomatik Purjör	-	60,40 TL

KOLLEKTÖR ve YERDEN ISITMA GRUPLARI

H-Ventil / By - Pass Bağlantı

TSEK



KOD	AÇIKLAMA	K.AD.	B.FİYATI
14.01.878	16 x 2 Deliksiz	40	41,36 TL
06.05.881	H - Ventil	40	79,10 TL

Yerden Isıtma Mini Küresel Vana

TSEK



KOD	AÇIKLAMA	K.AD.	B.FİYATI
05.01.312	1/2" 16 x 2 İç Dişli	180	16,78 TL
05.01.313	1/2" 17 x 2 İç Dişli	150	26,43 TL
05.02.311	3/8" 16 x 2 Dış Dişli	150	16,74 TL
05.02.312	1/2" 16 x 2 Dış Dişli	150	21,57 TL
05.02.313	1/2" 17 x 2 Dış Dişli	150	31,11 TL

Hortum Bağlantı Rakoru

78



KOD	AÇIKLAMA	K.AD.	B.FİYATI
06.03.319	16 x 2 Hortum - Hortum	250	12,99 TL
06.03.320	16 x 2 Hortum - Boru	250	12,13 TL

Kollektör Bağlantı Grubu



KOD	AÇIKLAMA	K.AD.	B.FİYATI
70.01.390	40'lık Kollektör Dolabı	1	147,70 TL
70.01.391	60'lık Kollektör Dolabı	1	178,20 TL
70.01.392	80'lık Kollektör Dolabı	1	221,50 TL
18.20.502	1" Kollektör Kelepçesi	40	9,31 TL
18.20.503	1 1/4" Kollektör Kelepçesi	30	12,96 TL
18.20.504	1" Kollektör Kelepçesi	40	10,04 TL

Yerden Isıtma Rakorları



KOD	AÇIKLAMA	K.AD.	B.FİYATI
06.02.315	16 x 2 İç Dişli	250	8,95 TL
06.02.316	17 x 2 İç Dişli	250	13,08 TL
06.01.317	17 x 2 Dış Dişli	250	12,86 TL
06.01.318	16 x 2 Dış Dişli	250	7,72 TL
06.01.314	16 x 2 Boru Bağ. Rakoru Dış Dişli	250	6,92 TL

KOLLEKTÖR ve YERDEN ISITMA GRUPLARI

Radyatör Bağlantı Borusu - Paslanmaz

Yeni
ürün



KOD	AÇIKLAMA	K.AD.	B.FİYATI
40.01.040	40 cm	100	11,94 TL
40.01.050	50 cm	100	13,93 TL
40.01.060	60 cm	100	15,90 TL
40.01.090	90 cm	100	22,67 TL

Radyatör Bağlantı Borusu - S'li - Rakorlu



KOD	AÇIKLAMA	K.AD.	B.FİYATI
40.04.040	16 x 2 40 cm	50	16,21 TL
40.04.050	16 x 2 50 cm	50	17,41 TL
40.04.060	16 x 2 60 cm	50	18,17 TL
40.04.090	16 x 2 90 cm	50	22,15 TL

Radyatör Bağlantı Borusu - Düz - Rakorlu



KOD	AÇIKLAMA	K.AD.	B.FİYATI
40.02.040	16 x 2 40 cm	70	15,58 TL
40.02.050	16 x 2 50 cm	70	16,83 TL
40.02.060	16 x 2 60 cm	50	17,55 TL
40.02.090	16 x 2 90 cm	50	20,95 TL

Radyatör Bağlantı Borusu - Dirsekli - Rakorlu



KOD	AÇIKLAMA	K.AD.	B.FİYATI
40.10.010	16 x 2 10 cm - 85°	200	12,56 TL
40.11.010	16 x 2 10 cm - 90°	200	12,56 TL
40.20.040	16 x 2 40 cm	50	16,35 TL
40.20.050	16 x 2 50 cm	50	17,64 TL
40.20.060	16 x 2 60 cm	50	18,41 TL
40.20.090	16 x 2 90 cm	50	22,02 TL





Dirsek yok, kaynak yok, avantaj çok..!

KAS-TAK Yeni Nesil Tesisat Sistemi ile
ev içi doğalgaz tesisatında ezber bozuldu.

Şimdi avantajlarla dolu KAS-TAK
sistemiyle tanışın...



KAS®

 / kastak.tesisat  / kastak_tesisat

www.kas.com.tr

 facebook.com/kasgrup
 twitter.com/kasgrup_

Flex Grubu



FLEX GRUPLARI

Örgülü Doğalgaz Bağlantı Flexi

TSE EN 14800



KOD	AÇIKLAMA	K.AD.	B.FİYATI
54.01.050	1/2" - 1/2" 50 cm	25	28,27 TL
54.01.075	1/2" - 1/2" 75 cm	25	32,75 TL
54.01.100	1/2" - 1/2" 100 cm	25	37,60 TL
54.01.125	1/2" - 1/2" 125 cm	25	40,09 TL
54.01.150	1/2" - 1/2" 150 cm	20	46,17 TL
54.01.175	1/2" - 1/2" 175 cm	20	51,80 TL
54.01.200	1/2" - 1/2" 200 cm	20	56,40 TL

Kombi Gaz Bağlantı Flexleri - Makaronlu

TSE EN 10380



KOD	AÇIKLAMA	K.AD.	B.FİYATI
42.20.030	3/4" - 3/4" 30 cm	50	16,59 TL
42.20.040	3/4" - 3/4" 40 cm	50	18,13 TL
42.20.050	3/4" - 3/4" 50 cm	50	19,59 TL
42.20.060	3/4" - 3/4" 60 cm	30	21,07 TL
42.20.090	3/4" - 3/4" 90 cm	30	27,80 TL
42.20.120	3/4" - 3/4" 120 cm	30	32,94 TL

Kombi Gaz Bağlantı Flexleri - Makaronlu

TSE EN 10380



KOD	AÇIKLAMA	K.AD.	B.FİYATI
42.15.030	3/4" - 1/2" 30 cm	50	21,85 TL
42.15.040	3/4" - 1/2" 40 cm	50	21,36 TL
42.15.050	3/4" - 1/2" 50 cm	50	24,56 TL
42.15.060	3/4" - 1/2" 60 cm	30	26,45 TL
42.15.090	3/4" - 1/2" 90 cm	50	32,45 TL
42.15.120	3/4" - 1/2" 120 cm	30	37,88 TL
42.15.150	3/4" - 1/2" 150 cm	20	42,24 TL

Not : Flexlerin Gövdesi 3/4, Somun 1/2, Nipel 3/4'tür.

Kombi Gaz Bağlantı Flexleri - Makaronlu

TSE EN 10380



KOD	AÇIKLAMA	K.AD.	B.FİYATI
41.17.030	3/4" - 1/2" 30 cm	50	19,28 TL
41.17.040	3/4" - 1/2" 40 cm	50	20,79 TL
41.17.050	3/4" - 1/2" 50 cm	50	22,59 TL
41.17.060	3/4" - 1/2" 60 cm	30	24,09 TL
41.17.090	3/4" - 1/2" 90 cm	30	29,32 TL
41.17.120	3/4" - 1/2" 120 cm	30	33,78 TL

Not : Flexlerin Gövdesi 1/2, Somun 1/2, Nipel 3/4'tür.

FLEX GRUPLARI

Kompansatör Bağlantı - Makaronlu

TSE EN 10380



KOD	AÇIKLAMA	K.AD.	B.FİYATI
52.02.060	1" Kaynaklı 60 cm	25	57,30 TL
52.12.065	1 1/4" Kaynaklı 65 cm	20	80,00 TL
52.22.075	1 1/2" Kaynaklı 75 cm	10	121,30 TL
52.32.085	2" Kaynaklı 85 cm	8	135,30 TL
51.57.060	1" Dış Dişli 60 cm	25	51,80 TL
51.59.065	1 1/4" Dış Dişli 65 cm	20	68,60 TL
51.61.075	1 1/2" Dış Dişli 75 cm	10	112,90 TL
51.63.085	2" Dış Dişli 85 cm	8	141,50 TL

Sayaç Bağlantı Flexi - Makaronlu

TSE TS EN 10380



KOD	AÇIKLAMA	K.AD.	B.FİYATI
50.26.020	1" G4 - G6 20 cm	30	29,14 TL
50.26.023	1" G4 - G6 23 cm	30	32,05 TL
50.26.025	1" G4 - G6 25 cm	25	29,92 TL
50.26.032	1" G4 - G6 32 cm	50	31,86 TL
50.41.035	1 1/2" G10 - G16 35 cm	10	93,80 TL
50.51.035	2" G25 35 cm	8	127,20 TL

Sayaç Bağlantı Flex Seti - Makaronlu

TSE TS EN 10380



KOD	AÇIKLAMA	K.AD.	B.FİYATI
50.32.020	1" 20 cm Ön Bağlantı	20	44,59 TL
50.30.025	1" 25 cm Ön Bağlantı	20	48,81 TL
50.30.032	1" 32 cm Ön Bağlantı	20	50,90 TL
50.31.020	1" 20 cm Yan Bağlantı	20	45,16 TL

Sayaç Bağlantı Elemanları

TSE TS EN 10380



KOD	AÇIKLAMA	K.AD.	B.FİYATI
46.02.440	7.5 cm Konsol Sacı - Ön Bağlantı	50	4,25 TL
46.02.450	8.5 cm Konsol Sacı - Ön Bağlantı	50	5,24 TL
46.02.452	9.5 cm Konsol Sacı - Ön Bağlantı	50	5,37 TL
46.02.453	10.5 cm Konsol Sacı - Ön Bağlantı	50	5,57 TL
46.02.451	Konsol Sacı - Yan Bağlantı	50	5,52 TL
46.20.460	1" Sayaç Rakoru (Döküm)	50	15,47 TL
46.20.461	1" Sayaç Rakoru (Kromlu Döküm)	50	17,94 TL
46.20.463	1" Sayaç Rakoru (Purjörülü)	50	23,47 TL
46.20.470	G 10 - 16 Sayaç Rakoru (Çelik)	50	60,10 TL
46.20.480	G 25 Sayaç Rakoru (Çelik)	25	77,40 TL

FLEX GRUPLARI

Kaskad Gaz Bağlantı Flexi



KOD	AÇIKLAMA	K.AD.	B.FİYATI
50.60.020	1" 20 cm Mak.	30	30,37 TL
50.60.030	1" 30 cm Mak.	20	39,96 TL
50.60.040	1" 40 cm Mak.	30	45,48 TL
50.60.050	1" 50 cm Mak.	25	47,76 TL

Not : Flexlerin bir tarafı 1" Nipel, diğer tarafı 1" Çakmalı Masuradır.

Brülör Bağlantı Flexleri - Makaronlu



KOD	AÇIKLAMA	K.AD.	B.FİYATI
53.03.017	1" 17 cm	20	35,25 TL
53.12.019	1 1/4" 19 cm	15	55,20 TL
53.22.021	1 1/2" 21 cm	10	64,30 TL
53.32.021	2" 21 cm	8	91,60 TL

Fancoil Flexleri - Çıplak



KOD	AÇIKLAMA	K.AD.	B.FİYATI
43.17.020	1/2" - 1/2" 20 cm	50	13,00 TL
43.17.030	1/2" - 1/2" 30 cm	50	13,76 TL
43.17.035	1/2" - 1/2" 35 cm	50	13,85 TL
43.17.040	1/2" - 1/2" 40 cm	50	15,11 TL
43.17.050	1/2" - 1/2" 50 cm	50	15,92 TL
43.17.060	1/2" - 1/2" 60 cm	50	16,92 TL
43.17.070	1/2" - 1/2" 70 cm	50	17,86 TL

KOD	AÇIKLAMA	K.AD.	B.FİYATI
43.19.020	3/4" - 3/4" 20 cm	50	14,99 TL
43.19.030	3/4" - 3/4" 30 cm	50	16,26 TL
43.19.035	3/4" - 3/4" 35 cm	50	16,90 TL
43.19.040	3/4" - 3/4" 40 cm	50	17,62 TL
43.19.050	3/4" - 3/4" 50 cm	50	18,79 TL
43.19.060	3/4" - 3/4" 60 cm	30	20,27 TL
43.19.070	3/4" - 3/4" 70 cm	30	21,77 TL

	N	S	
43.21.020	1/2" - 3/4" 20 cm	50	15,40 TL
43.21.030	1/2" - 3/4" 30 cm	50	16,08 TL
43.21.035	1/2" - 3/4" 35 cm	50	16,55 TL
43.21.040	1/2" - 3/4" 40 cm	50	17,00 TL
43.21.050	1/2" - 3/4" 50 cm	50	18,07 TL
43.21.060	1/2" - 3/4" 60 cm	30	18,47 TL
43.21.070	1/2" - 3/4" 70 cm	30	19,88 TL

	N	S	
43.23.020	3/4" - 1" 20 cm	30	28,16 TL
43.23.030	3/4" - 1" 30 cm	30	31,50 TL
43.23.035	3/4" - 1" 35 cm	30	29,99 TL
43.23.040	3/4" - 1" 40 cm	30	30,87 TL
43.23.050	3/4" - 1" 50 cm	30	34,24 TL
43.23.060	3/4" - 1" 60 cm	25	35,35 TL
43.23.070	3/4" - 1" 70 cm	25	36,87 TL

FLEX GRUPLARI

Fancoil Flexleri - İzoleli



KOD	AÇIKLAMA	K.AD.	B.FİYATI
43.18.020	1/2" - 1/2" 20 cm	25	15,51 TL
43.18.030	1/2" - 1/2" 30 cm	25	16,94 TL
43.18.035	1/2" - 1/2" 35 cm	25	17,10 TL
43.18.040	1/2" - 1/2" 40 cm	25	18,43 TL
43.18.050	1/2" - 1/2" 50 cm	25	19,89 TL
43.18.060	1/2" - 1/2" 60 cm	25	21,42 TL
43.18.070	1/2" - 1/2" 70 cm	25	22,81 TL

KOD	AÇIKLAMA	K.AD.	B.FİYATI
43.20.020	3/4" - 3/4" 20 cm	20	17,10 TL
43.20.030	3/4" - 3/4" 30 cm	20	19,00 TL
43.20.035	3/4" - 3/4" 35 cm	20	19,68 TL
43.20.040	3/4" - 3/4" 40 cm	20	20,73 TL
43.20.050	3/4" - 3/4" 50 cm	20	22,72 TL
43.20.060	3/4" - 3/4" 60 cm	20	24,50 TL
43.20.070	3/4" - 3/4" 70 cm	20	26,56 TL

	N	S		
43.22.020	1/2" - 3/4"	20 cm	25	17,29 TL
43.22.030	1/2" - 3/4"	30 cm	25	18,70 TL
43.22.035	1/2" - 3/4"	35 cm	25	19,08 TL
43.22.040	1/2" - 3/4"	40 cm	25	20,21 TL
43.22.050	1/2" - 3/4"	50 cm	25	21,76 TL
43.22.060	1/2" - 3/4"	60 cm	25	22,93 TL
43.22.070	1/2" - 3/4"	70 cm	25	24,49 TL

	N	S		
43.24.020	3/4" - 1"	20 cm	25	30,26 TL
43.24.030	3/4" - 1"	30 cm	25	33,56 TL
43.24.035	3/4" - 1"	35 cm	25	32,72 TL
43.24.040	3/4" - 1"	40 cm	25	34,82 TL
43.24.050	3/4" - 1"	50 cm	25	36,64 TL
43.24.060	3/4" - 1"	60 cm	25	37,85 TL
43.24.070	3/4" - 1"	70 cm	25	39,37 TL

Su Bağlantı Flexleri



KOD	AÇIKLAMA	K.AD.	B.FİYATI
44.20.010	1/2" - 1/2" 10 cm	100	17,09 TL
44.20.020	1/2" - 1/2" 20 cm	100	18,25 TL
44.20.030	1/2" - 1/2" 30 cm	75	19,13 TL
44.20.040	1/2" - 1/2" 40 cm	75	20,37 TL
44.20.050	1/2" - 1/2" 50 cm	50	21,17 TL
44.20.060	1/2" - 1/2" 60 cm	50	22,34 TL
44.20.090	1/2" - 1/2" 90 cm	50	25,73 TL

Su Bağlantı Flexleri



KOD	AÇIKLAMA	K.AD.	B.FİYATI
44.22.010	1/2" - 3/4" 10 cm	100	21,21 TL
44.22.020	1/2" - 3/4" 20 cm	50	22,94 TL
44.22.030	1/2" - 3/4" 30 cm	50	24,04 TL
44.22.040	1/2" - 3/4" 40 cm	50	25,03 TL
44.22.050	1/2" - 3/4" 50 cm	50	26,16 TL
44.22.060	1/2" - 3/4" 60 cm	50	27,19 TL

45.23.010	3/4" - 3/4" 10 cm	60	23,07 TL
45.23.020	3/4" - 3/4" 20 cm	60	24,48 TL
45.23.030	3/4" - 3/4" 30 cm	50	25,73 TL
45.23.040	3/4" - 3/4" 40 cm	50	26,92 TL
45.23.050	3/4" - 3/4" 50 cm	50	28,36 TL
45.23.060	3/4" - 3/4" 60 cm	30	29,56 TL

FLEX GRUPLARI

Klozet Bağlantı Flexi (Şeffaf Kılıflı)



KOD	AÇIKLAMA	K.AD.	B. FİYATI
56.43.050	3/8" - 3/8" 50 cm	50	13,59 TL
56.43.070	3/8" - 3/8" 70 cm	50	15,40 TL

Klozet Bağlantı Flexi (Şeffaf Kılıflı)



KOD	AÇIKLAMA	K.AD.	B. FİYATI
56.45.050	3/8" - 1/2" 50 cm	50	12,71 TL
56.45.070	3/8" - 1/2" 70 cm	50	14,37 TL

Yeni Paslanmaz Rezervuar Bağlantı Hortumu

Klasik rezervuar bağlantı hortumundan kaynaklı su baskınlarına son.

Paslanmaz, yırtılmaz, ses yapmaz,
uzun ömürlü rezervuar flexi...



FLEX GRUPLARI

KUTU (REGÜLATÖR) BAĞLANTI FLEXLERİ TS EN 10380

Nipel + Nipel Serisi Kutu Bağlantı Flexi



KOD	AÇIKLAMA	K.AD.	B.FİYATI
51.07.020	1 1/4" 20 cm	25	37,79 TL
51.08.020	1 1/4" 20 cm (Paslanmaz Nipel)	25	128,50 TL
51.09.020	1 1/4" 20 cm (Makaronlu)	25	39,94 TL
51.10.020	1 1/4" 20 cm (Mak. Paslanmaz N.)	25	130,20 TL
51.11.030	1 1/4" 30 cm (Makaronlu)	20	46,70 TL
51.12.030	1 1/4" 30 cm (Mak. Paslanmaz N.)	20	124,60 TL



KOD	AÇIKLAMA	K.AD.	B.FİYATI
51.64.017	1 1/4" 11/11 Diş 16,5 cm (Makaronlu)	25	38,32 TL
51.65.025	1 1/4" 11/11 Diş 25 cm (Makaronlu)	25	44,39 TL



KOD	AÇIKLAMA	K.AD.	B.FİYATI
51.15.020	1 1/4" 11/11 Diş 20 cm (Makaronlu)	25	41,34 TL

KOD	AÇIKLAMA	K.AD.	B.FİYATI
51.66.025	1 1/4" 11/11 Diş 25 cm	25	43,47 TL
51.67.025	1 1/4" 11/11 Diş 25 cm (Makaronlu)	25	46,41 TL



KOD	AÇIKLAMA	K.AD.	B.FİYATI
51.23.030	1 1/4" 14/11 Diş 30 cm (Makaronlu)	25	55,20 TL

Kısa Nipel + Boru Serisi Kutu Bağlantı Flexi

87



KOD	AÇIKLAMA	K.AD.	B.FİYATI
51.24.034	2" 11/11 Diş 34 cm	8	102,90 TL
51.25.034	2" 11/11 Diş 34 cm (Makaronlu)	8	108,80 TL



KOD	AÇIKLAMA	K.AD.	B.FİYATI
51.42.020	1 1/4" 14 Diş 20 cm	25	50,30 TL
51.43.020	1 1/4" 14 Diş 20 cm (Makaronlu)	25	51,70 TL



KOD	AÇIKLAMA	K.AD.	B.FİYATI
51.52.027	1 1/4" 11/11 Diş 27 cm	20	47,66 TL
51.53.027	1 1/4" 11/11 Diş 27 cm (Makaronlu)	20	171,60 TL



KOD	AÇIKLAMA	K.AD.	B.FİYATI
51.44.020	1 1/4" 11 Diş 20 cm	25	50,60 TL
51.45.020	1 1/4" 11 Diş 20 cm (Makaronlu)	25	52,30 TL

FLEX GRUPLARI

Nipel + Rakor Serisi Kutu Bağlantı Flexi



KOD	AÇIKLAMA	K.AD.	B.FİYATI
51.41.020	1 1/4" 11 Diş 20 cm (Makaronlu)	25	55,40 TL

Nipel + Boru Serisi Kutu Bağlantı Flexi



KOD	AÇIKLAMA	K.AD.	B.FİYATI
51.36.020	1 1/4" 11 Diş 20 cm	25	44,13 TL
51.37.020	1 1/4" 11 Diş 20 cm (Makaronlu)	25	45,98 TL

Kısa Nipel + Nipel Serisi Kutu Bağlantı Flexi



KOD	AÇIKLAMA	K.AD.	B.FİYATI
51.48.017	1 1/4" 11/14 Diş 16,5 cm	25	36,31 TL
51.49.017	1 1/4" 11/14 Diş 16,5 cm (Makaronlu)	25	38,15 TL



KOD	AÇIKLAMA	K.AD.	B.FİYATI
51.38.025	1 1/4" 11 Diş 25 cm	20	42,94 TL
51.39.025	1 1/4" 11 Diş 25 cm (Makaronlu)	20	45,55 TL

88

Rakor + Boru Serisi Kutu Bağlantı Flexi

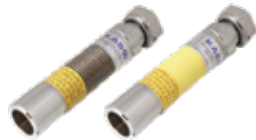

KOD	AÇIKLAMA	K.AD.	B.FİYATI
51.34.020	1 1/4" 11 Diş 20 cm	25	54,30 TL
51.35.020	1 1/4" 11 Diş 20 cm (Makaronlu)	20	57,10 TL



KOD	AÇIKLAMA	K.AD.	B.FİYATI
51.50.027	1 1/4" 11/11 Diş 27 cm	20	49,43 TL
51.51.027	1 1/4" 11/11 Diş 27 cm (Makaronlu)	20	52,10 TL
51.70.027	1 1/4" 11/11 Diş 27 cm (Paslanmaz)	20	84,90 TL

FLEX GRUPLARI

Nipel + Manşon Serisi Kutu Bağlantı Flexi



KOD	AÇIKLAMA	K.AD.	B.FİYATI
51.21.020	1 1/4" 11/11 Diş 20 cm (Makaronlu)	25	46,10 TL



KOD	AÇIKLAMA	K.AD.	B.FİYATI
51.26.020	1 1/4" 14/11 Diş 20 cm	25	49,14 TL
51.27.020	1 1/4" 14/11 Diş 20 cm (Makaronlu)	25	50,90 TL



KOD	AÇIKLAMA	K.AD.	B.FİYATI
51.28.020	2" 11/11 Diş 20 cm	8	90,20 TL
51.29.020	2" 11/11 Diş 20 cm (Makaronlu)	8	93,20 TL



KOD	AÇIKLAMA	K.AD.	B.FİYATI
51.30.030	2" 11/11 Diş 30 cm	8	102,10 TL
51.31.030	2" 11/11 Diş 34 cm (Makaronlu)	8	107,70 TL



KOD	AÇIKLAMA	K.AD.	B.FİYATI
51.68.022	1 1/4" 11/11 Diş 21,5 cm (Makaronlu)	25	51,50 TL
51.69.022	1 1/2" 11/11 Diş 21,5 cm (Makaronlu)	15	67,40 TL
51.03.030	2" 30 cm Kutu Flex	8	96,10 TL
51.04.030	2" 30 cm Kutu Flex (Makaronlu)	8	100,70 TL
51.05.030	2" 30 cm Kutu Flex N-N	8	96,20 TL
51.06.030	2" 30 cm Kutu Flex N-N (Makaronlu)	8	101,30 TL

FLEX GRUPLARI

KAS-TAK Daire İçi Tesisat Hortumları

 TS EN 15266



KOD	AÇIKLAMA	K.AD.	B.FİYATI
62.30.016	DN 16 - 45 mt	1	1,106,00 TL
62.30.020	DN 20 - 30 mt	1	878,00 TL
62.30.025	DN 25 - 25 mt	1	966,00 TL
62.30.050	DN 25 - 50 mt	1	1,903,00 TL

T Bağlantı Rakorları

 TS EN 15266



KOD	AÇIKLAMA	K.AD.	B.FİYATI
61.20.020	DN 25 x DN 20 x DN 20	10	87,60 TL
61.20.021	DN 20 x DN 25 x DN 20	10	88,30 TL
61.20.025	DN 25 x DN 20 x DN 25	10	103,20 TL
61.25.020	DN 25 x DN 25 x DN 20	10	103,20 TL
61.25.025	DN 25 x DN 25 x DN 25	10	96,90 TL

Hortum Bağlantı Rakorları



KOD	AÇIKLAMA	K.AD.	B.FİYATI
60.16.012	DN 16 x 1/2"	30	34,30 TL
60.16.016	DN 16 x 3/4"	24	34,02 TL
60.20.012	DN 20 x 1/2"	24	42,09 TL
60.20.016	DN 20 x 3/4"	24	42,22 TL
60.25.012	DN 25 x 1/2" Diş	24	47,42 TL
60.25.016	DN 25 x 3/4" Diş	24	50,40 TL
60.25.025	DN 25 x 1" Diş	24	50,30 TL

Bağlantı Kelepçeleri



KOD	AÇIKLAMA	K.AD.	B.FİYATI
60.04.012	1/2" - 3/4" Vana Bağlantı	100	2,79 TL
60.04.020	DN 20 Te Bağlantı	100	1,31 TL
60.04.025	DN 25 Te Bağlantı	100	2,19 TL
60.05.016	DN 16 Hortum Bağlantı	100	3,84 TL
60.05.020	DN 20 Hortum Bağlantı	100	4,54 TL
60.05.025	DN 25 Hortum Bağlantı	100	4,84 TL

FLEX GRUPLARI

Hortum Kanalları ve Ek Parçaları - KREM



KOD	AÇIKLAMA	K.AD.	B.FİYATI
63.03.001	Hortum Kanalı 3 mt	9	37,74 TL
63.01.003	L Köşe	50	4,42 TL
63.01.004	Dış Köşe	50	4,49 TL
63.01.005	İç Köşe	50	4,49 TL
63.01.006	Duvar Geçiş Kapağı (Kapalı)	50	2,95 TL
63.01.007	Köpük Bağlantı Kapağı (Açık)	50	3,15 TL
63.01.008	Bağlantı Geçiş Körüğü 1 mt	1	26,30 TL

Hortum Kanalları ve Ek Parçaları - BEYAZ



KOD	AÇIKLAMA	K.AD.	B.FİYATI
63.04.001	Hortum Kanalı 3 mt	9	37,74 TL
63.02.003	L Köşe	50	4,42 TL
63.02.004	Dış Köşe	50	4,49 TL
63.02.005	İç Köşe	50	4,49 TL
63.02.006	Duvar Geçiş Kapağı (Kapalı)	50	2,95 TL
63.02.007	Köpük Bağlantı Kapağı (Açık)	50	3,15 TL
63.02.008	Bağlantı Geçiş Körüğü 1 mt	1	26,30 TL

Sayaç Bağlantı Rakorları (Test Purjölü)



KOD	AÇIKLAMA	K.AD.	B.FİYATI
60.25.116	DN 25 - 3/4" Dış Dişli Selenoid Bağlantılı	-	70,70 TL
60.25.117	DN 25 - 1" Dış Dişli Selenoid Bağlantılı	-	72,00 TL
60.25.118	DN 25 - 1" İç Dişli	-	63,60 TL
60.25.125	DN 25 - 1" Rakorlu	-	84,20 TL

Montaj Aletleri



KOD	AÇIKLAMA	K.AD.	B.FİYATI
49.51.001	Boru Kesme Aparatı	-	319,30 TL
63.01.009	T Sıkma Aparatı	-	204,80 TL
94.00.003	Kanal Kesme Makası	-	0,00 TL

Isıtma ve İçme Suyu Tesisatlarında KAS Kalitesi...

KAS güveni ve kalitesi şimdi
PPRC ürünleriyle ısıtma ve içme
suyu tesisatlarında.
KAS hem kullanıcının hem
uygulayıcının yanında.

PPRC Sade Boru, PPRC Compozite Boru,
PPRC Ortadan Alüminyum Folyolu Boru ve PPRC
Fittings parçalarında 20 mm'den 110 mm'ye kadar tüm
parçaların üretimini yapan KAS, yalnız kullanıcıya değil
uygulayıcıya da pek çok yarar sağlıyor.
KAS PPRC ürünler kaygan ve parlak iç yüzeyle
üretiliyor. Bu sayede suyun rengi ve tadı kesinlikle
değişmiyor. Folyosu ortada olduğu için kesme, tıraşlama
ve montaj sürelerini maksimum düzeyde kısaltıyor. Fireyi
sıfıra düşüren KAS PPRC ürünleri aynı zamanda kaynak
noktasında daralma yaşanmadığından yüksek kaynak
performansı sağlıyor.



PPRC Grubu

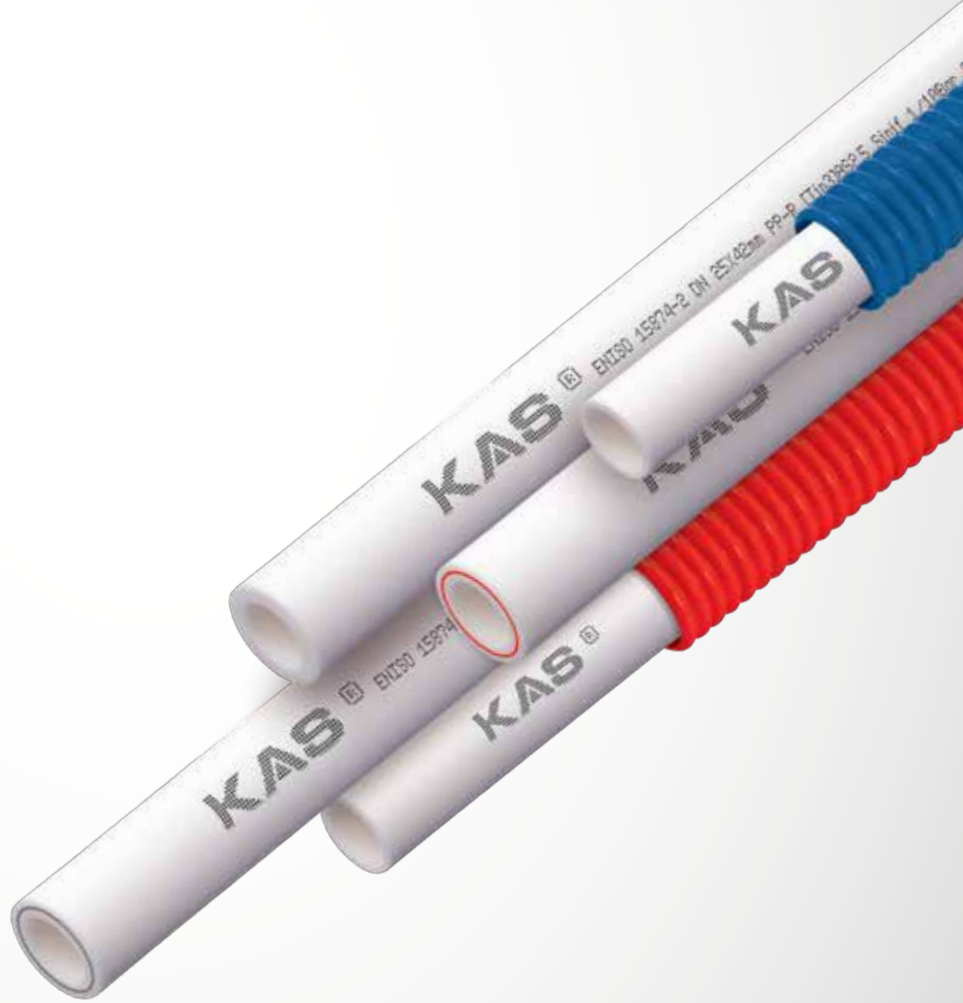

PPRC GRUPLARI

Pex-B / Pe-Rt Boru



KOD	AÇIKLAMA	K.AD.	B.FİYATI
80.00.016	Pex-B 16 x 2	200	3,54 TL
80.01.016	Pex-B 16 x 2 Mavi Kılıflı	100	5,18 TL
80.02.016	Pex-B 16 x 2 Kırmızı Kılıflı	100	5,18 TL
81.00.016	Pex-B Oksijen Bariyerli	160	5,12 TL
81.01.016	Pex-B Oksijen Bariyerli Mavi Kılıflı	100	6,63 TL
81.02.016	Pex-B Oksijen Bariyerli Kırmızı Kılıflı	100	6,63 TL
80.20.016	Pe-Rt 16 x 2 Boru	200	2,67 TL
80.21.016	Pe-Rt 16 x 2 Kılıflı Boru (Mavi)	100	3,92 TL
80.22.016	Pe-Rt 16 x 2 Kılıflı Boru (Kırmızı)	100	3,92 TL
80.10.016	Pe-Rt 16 x 2 Oksijen Bariyerli Boru	160	3,45 TL
80.11.016	Pe-Rt 16 x 2 Oks. Bar. Kılıflı Boru (Mavi)	100	4,63 TL
80.12.016	Pe-Rt 16 x 2 Oks. Bar. Kılıflı Boru (Kırmızı)	100	4,63 TL

PPRC Alüminyum Folyolu Boru (PN25)



KOD	AÇIKLAMA	K.AD.	B.FİYATI
94.11.020	20 mm	4 x 25	7,30 TL
94.11.025	25 mm	4 x 20	10,41 TL
94.11.032	32 mm	4 x 15	16,90 TL
94.11.040	40 mm	4 x 10	25,47 TL
94.11.050	50 mm	4 x 5	39,86 TL
94.11.063	63 mm	4 x 4	59,10 TL

PPRC Boru (PN16)



KOD	AÇIKLAMA	K.AD.	B.FİYATI
94.02.020	20 mm	4 x 25	3,70 TL
94.02.025	25 mm	4 x 20	5,53 TL
94.02.032	32 mm	4 x 15	9,24 TL
94.02.040	40 mm	4 x 10	14,33 TL
94.02.050	50 mm	4 x 5	23,83 TL
94.02.063	63 mm	4 x 4	36,02 TL
94.02.075	75 mm	4 x 3	51,40 TL

PPRC Boru (PN20)



KOD	AÇIKLAMA	K.AD.	B.FİYATI
94.03.020	20 mm	4 x 25	4,13 TL
94.03.025	25 mm	4 x 20	6,41 TL
94.03.032	32 mm	4 x 15	12,03 TL
94.03.040	40 mm	4 x 10	19,11 TL
94.03.050	50 mm	4 x 5	29,63 TL
94.03.063	63 mm	4 x 4	47,04 TL
94.03.075	75 mm	4 x 3	71,90 TL
94.03.090	90 mm	4 x 2	120,10 TL
94.03.110	110 mm	4 x 1	178,30 TL

PPRC GRUPLARI

PPRC Kompozit Boru (PN20)



KOD	AÇIKLAMA	K.AD.	B.FİYATI
94.06.020	20 mm	4 x 25	4,25 TL
94.06.025	25 mm	4 x 20	7,05 TL
94.06.032	32 mm	4 x 15	11,21 TL
94.06.040	40 mm	4 x 10	16,98 TL
94.06.050	50 mm	4 x 5	27,99 TL
94.06.063	63 mm	4 x 4	42,51 TL

İnegal T



KOD	AÇIKLAMA	K.AD.	B.FİYATI
94.16.001	25x20x20 mm	200	1,23 TL
94.16.002	25x20x25 mm	150	1,32 TL
94.16.003	32x20x20 mm	90	2,31 TL
94.16.004	32x20x32 mm	80	2,38 TL
94.16.005	32x25x20 mm	90	2,06 TL
94.16.006	32x25x25 mm	90	2,08 TL
94.16.007	32x25x32 mm	80	2,42 TL
94.16.008	40x20x40 mm	60	3,67 TL
94.16.009	40x25x40 mm	60	3,84 TL
94.16.010	40x32x40 mm	60	3,99 TL
94.16.011	50x20x50 mm	32	7,47 TL
94.16.012	50x25x50 mm	32	7,42 TL
94.16.013	50x32x50 mm	32	7,40 TL
94.16.014	50x40x50 mm	32	7,85 TL
94.16.015	63x20x63 mm	18	12,47 TL
94.16.016	63x25x63 mm	18	13,88 TL
94.16.017	63x32x63 mm	18	14,25 TL
94.16.018	63x40x63 mm	18	14,58 TL
94.16.019	63x50x63 mm	18	15,54 TL

PPRC Kompozit Boru (PN25)



KOD	AÇIKLAMA	K.AD.	B.FİYATI
94.07.020	20 mm	4 x 25	5,38 TL
94.07.025	25 mm	4 x 20	7,51 TL
94.07.032	32 mm	4 x 15	13,22 TL
94.07.040	40 mm	4 x 10	20,52 TL
94.07.050	50 mm	4 x 5	32,98 TL
94.07.063	63 mm	4 x 4	50,90 TL
94.07.075	75 mm	4 x 3	81,60 TL
94.07.090	90 mm	4 x 2	115,90 TL
94.07.110	110 mm	4 x 1	176,40 TL

T Parça



KOD	AÇIKLAMA	K.AD.	B.FİYATI
94.15.020	20 mm	240	0,85 TL
94.15.025	25 mm	150	1,24 TL
94.15.032	32 mm	75	2,40 TL
94.15.040	40 mm	50	4,04 TL
94.15.050	50 mm	30	7,40 TL
94.15.063	63 mm	16	14,31 TL
94.15.075	75 mm	12	22,90 TL
94.15.090	90 mm	6	39,68 TL
94.15.110	110 mm	4	64,80 TL

PPRC GRUPLARI

Dirsek 45°



KOD	AÇIKLAMA	K.AD.	B.FİYATI
94.14.020	20 mm	400	0,77 TL
94.14.025	25 mm	300	1,02 TL
94.14.032	32 mm	150	1,78 TL
94.14.040	40 mm	80	3,11 TL
94.14.050	50 mm	48	5,96 TL
94.14.063	63 mm	21	10,75 TL
94.14.075	75 mm	18	19,74 TL
94.14.090	90 mm	12	35,49 TL
94.14.110	110 mm	16	52,20 TL

Dirsek 90°



KOD	AÇIKLAMA	K.AD.	B.FİYATI
94.13.020	20 mm	400	0,53 TL
94.13.025	25 mm	200	0,80 TL
94.13.032	32 mm	125	1,60 TL
94.13.040	40 mm	60	3,36 TL
94.13.050	50 mm	40	6,18 TL
94.13.063	63 mm	18	10,91 TL
94.13.075	75 mm	12	17,21 TL
94.13.090	90 mm	6	32,90 TL
94.13.110	110 mm	3	53,80 TL

Redüksiyon



KOD	AÇIKLAMA	K.AD.	B.FİYATI
94.19.001	25 x 20 mm	600	0,47 TL
94.19.002	32 x 20 mm	300	0,68 TL
94.19.003	32 x 25 mm	300	0,73 TL
94.19.005	40 x 25 mm	200	1,44 TL
94.19.006	40 x 32 mm	160	1,43 TL
94.19.009	50 x 32 mm	125	2,63 TL
94.19.010	50 x 40 mm	100	3,06 TL
94.19.014	63 x 40 mm	64	4,95 TL
94.19.015	63 x 50 mm	52	5,82 TL

Manşon



KOD	AÇIKLAMA	K.AD.	B.FİYATI
94.17.020	20 mm	600	0,37 TL
94.17.025	25 mm	300	0,59 TL
94.17.032	32 mm	200	1,20 TL
94.17.040	40 mm	125	2,06 TL
94.17.050	50 mm	80	3,97 TL
94.17.063	63 mm	36	7,10 TL
94.17.075	75 mm	24	11,05 TL
94.17.090	90 mm	12	18,19 TL
94.17.110	110 mm	4	28,95 TL

PPRC GRUPLARI

C Kavis



KOD	AÇIKLAMA	K.AD.	B.FİYATI
94.12.220	20 mm	120	1,62 TL
94.12.225	25 mm	120	2,54 TL
94.12.232	32 mm	60	5,36 TL

Kapama Başlığı



KOD	AÇIKLAMA	K.AD.	B.FİYATI
94.18.020	20 mm	800	0,52 TL
94.18.025	25 mm	500	0,71 TL
94.18.032	32 mm	300	1,14 TL
94.18.040	40 mm	200	1,69 TL
94.18.050	50 mm	100	4,52 TL
94.18.063	63 mm	60	6,28 TL
94.18.075	75 mm	40	10,20 TL
94.18.090	90 mm	24	14,04 TL
94.18.110	110 mm	12	28,65 TL

Kavis



KOD	AÇIKLAMA	K.AD.	B.FİYATI
94.12.020	20 mm	150	2,03 TL
94.12.025	25 mm	60	3,17 TL
94.12.032	32 mm	40	6,41 TL
94.12.040	40 mm	20	10,78 TL

Manşonlu Kavis



KOD	AÇIKLAMA	K.AD.	B.FİYATI
94.12.120	20 mm	60	2,40 TL
94.12.125	25 mm	75	3,49 TL
94.12.132	32 mm	40	7,74 TL

PPRC GRUPLARI

Kuyruklu Dirsek 90°



KOD	AÇIKLAMA	K.AD.	B.FİYATI
94.13.220	20 mm	300	1,00 TL
94.13.225	25 mm	150	1,62 TL
94.13.232	32 mm	90	2,65 TL

Oynar Başlıklı Rakorlar - Kromlu



KOD	AÇIKLAMA	K.AD.	B.FİYATI
80.21.730	1/2" İç Dişli Rakor	100	8,64 TL
80.21.731	3/4" İç Dişli Rakor	75	11,96 TL
80.21.732	1" İç Dişli Rakor	50	14,29 TL
80.21.733	1 1/4" İç Dişli Rakor	25	25,05 TL
80.21.734	1 1/2" İç Dişli Rakor	15	42,17 TL
80.21.735	2" İç Dişli Rakor	10	70,10 TL
80.21.750	1/2" Dış Dişli Rakor	100	9,28 TL
80.21.751	3/4" Dış Dişli Rakor	75	13,98 TL
80.21.752	1" Dış Dişli Rakor	50	17,77 TL
80.21.753	1 1/4" Dış Dişli Rakor	25	29,97 TL
80.21.754	1 1/2" Dış Dişli Rakor	15	48,93 TL
80.21.755	2" Dış Dişli Rakor	10	76,50 TL

Dış Dişli Nipel



KOD	AÇIKLAMA	K.AD.	B.FİYATI
94.23.001	20 mm x 1/2"	125	5,38 TL
94.23.002	20 mm x 3/4"	80	8,31 TL
94.23.003	25 mm x 1/2"	80	6,09 TL
94.23.004	25 mm x 3/4"	80	7,92 TL
94.23.005	32 mm x 1/2"	50	7,28 TL
94.23.006	32 mm x 3/4"	50	8,24 TL
94.23.007	32 mm x 1"	50	12,23 TL
94.23.008	40 mm x 1/4"	21	39,53 TL
94.23.009	50 mm x 1/2"	21	47,50 TL
94.23.010	63 mm x 2"	12	69,40 TL

İç Dişli Nipel



KOD	AÇIKLAMA	K.AD.	B.FİYATI
94.22.001	20 mm x 1/2"	150	4,45 TL
94.22.002	20 mm x 3/4"	80	6,46 TL
94.22.003	25 mm x 1/2"	80	4,86 TL
94.22.004	25 mm x 3/4"	80	6,39 TL
94.22.005	32 mm x 1/2"	50	6,16 TL
94.22.006	32 mm x 3/4"	50	7,42 TL
94.22.007	32 mm x 1"	50	10,87 TL
94.22.008	40 mm x 1/4"	24	28,62 TL
94.22.009	50 mm x 1/2"	18	36,38 TL
94.22.010	63 mm x 2"	12	49,80 TL

PPRC GRUPLARI

Dış Dişli Dirsek



KOD	AÇIKLAMA	K.AD.	B.FİYATI
94.25.001	20 mm x 1/2"	80	5,68 TL
94.25.002	20 mm x 3/4"	60	8,70 TL
94.25.003	25 mm x 1/2"	60	6,71 TL
94.25.004	25 mm x 3/4"	60	8,65 TL
94.25.006	32 mm x 3/4"	30	10,59 TL
94.25.007	32 mm x 1"	30	15,69 TL

İç Dişli Dirsek



KOD	AÇIKLAMA	K.AD.	B.FİYATI
94.24.001	20 mm x 1/2"	120	4,73 TL
94.24.002	20 mm x 3/4"	100	6,92 TL
94.24.003	25 mm x 1/2"	60	5,13 TL
94.24.004	25 mm x 3/4"	60	6,97 TL
94.24.006	32 mm x 3/4"	30	9,72 TL
94.24.007	32 mm x 1"	30	13,24 TL

Dış Dişli T



KOD	AÇIKLAMA	K.AD.	B.FİYATI
94.27.001	20 mm x 1/2"	80	6,23 TL
94.27.002	20 mm x 3/4"	75	8,60 TL
94.27.003	25 mm x 1/2"	50	6,69 TL
94.27.004	25 mm x 3/4"	50	9,22 TL
94.27.006	32 mm x 3/4"	30	9,89 TL
94.27.007	32 mm x 1"	30	12,99 TL

İç Dişli T



KOD	AÇIKLAMA	K.AD.	B.FİYATI
94.26.001	20 mm x 1/2"	80	4,95 TL
94.26.002	20 mm x 3/4"	75	7,10 TL
94.26.003	25 mm x 1/2"	50	5,91 TL
94.26.004	25 mm x 3/4"	50	7,37 TL
94.26.006	32 mm x 3/4"	30	10,47 TL
94.26.007	32 mm x 1"	30	13,33 TL

PPRC GRUPLARI

Dış Dişli Batarya Altı



KOD	AÇIKLAMA	K.AD.	B.FİYATI
94.29.001	20 mm x 1/2"	75	7,01 TL

İç Dişli Batarya Altı



KOD	AÇIKLAMA	K.AD.	B.FİYATI
94.28.001	20 mm x 1/2"	75	5,09 TL
94.28.002	25 mm x 1/2"	60	6,26 TL

100

Oynar Başlıklı Rakor



KOD	AÇIKLAMA	K.AD.	B.FİYATI
94.30.001	20 mm x 1/2"	200	13,15 TL
94.30.002	25 mm x 3/4"	150	17,60 TL

Oynar Başlıklı Rakor



KOD	AÇIKLAMA	K.AD.	B.FİYATI
94.30.003	20 mm x 1/2"	200	14,93 TL
94.30.004	25 mm x 3/4"	150	18,97 TL

PPRC GRUPLARI

Batarya Altı (Tek Hat)



KOD	AÇIKLAMA	K.AD.	B.FİYATI
94.28.006	20 mm x 1/2"	50	14,04 TL

Batarya Altı (Çift Hat)



KOD	AÇIKLAMA	K.AD.	B.FİYATI
94.28.004	20 mm x 1/2"	50	14,90 TL

Kombi Bağlantı Seti



KOD	AÇIKLAMA	K.AD.	B.FİYATI
94.37.440	8'li Düz Set	20	63,60 TL
94.37.441	8'li Köşe Set	20	64,20 TL
94.37.442	10'lu Düz Set	12	81,10 TL
94.37.443	10'lu Köşe Set	12	81,80 TL

Stop Vana



KOD	AÇIKLAMA	K.AD.	B.FİYATI
94.33.676	20 mm x 1/2"	40	18,86 TL
94.33.677	25 mm x 3/4"	30	23,12 TL

PPRC GRUPLARI

Küresel Vana



KOD	AÇIKLAMA	K.AD.	B.FİYATI
94.33.670	1/2"	50	8,64 TL
94.33.671	3/4"	50	9,92 TL
94.33.672	1"	40	14,05 TL
94.33.673	1 1/4"	10	27,86 TL
94.33.674	1 1/2"	6	54,50 TL
94.33.675	2"	4	87,00 TL

Pislik Tutucu



KOD	AÇIKLAMA	K.AD.	B.FİYATI
94.33.680	1/2"	50	7,94 TL
94.33.681	3/4"	40	10,58 TL

Kelepçe



KOD	AÇIKLAMA	K.AD.	B.FİYATI
94.20.020	20 mm Tekli	900	0,35 TL
94.20.025	25 mm Tekli	900	0,39 TL
94.20.032	32 mm Tekli	400	0,67 TL
94.20.040	40 mm Tekli	300	0,86 TL
94.20.220	20 mm Çiftli	400	0,59 TL
94.20.225	25 mm Çiftli	300	0,80 TL
94.20.232	32 mm Çiftli	200	0,96 TL

Kör Tapa



KOD	AÇIKLAMA	K.AD.	B.FİYATI
94.21.001	20 mm	900	0,34 TL
94.21.002	25 mm	600	0,42 TL
94.21.011	20 mm (Uzun)	900	0,45 TL

ONLINE MÜŞTERİ HİZMETLERİ

www.kas.com.tr

Online ileti, anlık takip, kolay kullanım,

HIZLI SONUÇ ...





KAS[®]

w w w . k a s . c o m . t r

Esenkent Mah. Dudullu OSB 2.Caddesi
No:6 Ümraniye - İstanbul / TÜRKİYE

Tel : +90 216 527 1 527 PBX

Faks : +90 216 499 74 76

E-Posta : info@kas.com.tr